



IQ-Competino+ Version 1.0

BRAUNIGER Flugelectronic GmbH
Dr.-Karl-Slevogt-Str.5 D-82362 Weilheim, Tel. +49 881 64750
info@brauniger.com www.brauniger.com

Table of Contents

1	Operation.....	4
1.1	The instrument.....	4
1.2	Switching-on and switching-off the Competino+.....	5
1.3	Keypad and summary of display screen.....	5
1.4	First steps.....	9
1.4.1	Prior to the first flight.....	9
1.4.2	At take-off starting point.....	9
1.4.3	For what do I have to pay attention during the flight?.....	9
1.4.4	Data analysis after the flight.....	9
1.5	User defined fields.....	10
1.6	Entering Text.....	10
1.7	Menu Sequence.....	11
2	Display screens.....	12
2.1	Altimeter and air pressure.....	12
2.1.1	Altimeter A1, absolute altitude.....	12
2.1.2	Altimeter A2, relative altitude.....	13
2.1.3	Altimeter A3, cumulated altitude.....	13
2.2	Variometer functions.....	14
2.2.1	Analog Vario.....	14
2.2.2	Digital-Vario average value or Netto-Vario.....	14
2.2.3	Acoustics and volume level (Sound).....	15
2.3	Speed.....	15
2.3.1	Speed without Speed Sensor.....	17
2.3.2	Stallalarm.....	17
2.4	Time of day and date.....	17
2.5	Temperature.....	18
2.6	Navigation.....	18
2.6.1	Assessment of reception quality.....	18
2.6.2	Compass and flight direction.....	19
2.6.3	Track and Bearing.....	19
2.6.4	Waypoints and coordinates.....	20
2.6.5	Flying Routes.....	23
2.6.6	The Competition-Route.....	24
2.6.7	Diff. BGGoal.....	28
2.6.8	Relocating Thermals.....	29
2.6.9	XT Error, Crosstrack Error.....	29
2.6.10	Airspace CTR (Restricted areas).....	29
2.7	Flight optimisation.....	31
2.7.1	Groundspeed (speed over ground).....	31
2.7.2	Head-, Cross or Tail wind; the wind component.....	31
2.7.3	Winddirection and wind speed.....	31
2.7.4	Glide ratio (= L/D ratio).....	32
2.7.5	Safety altitude over path for best Glide Diff.BGWayp and Diff.BGGoal.....	32
2.7.6	Display screen final approach.....	33
2.8	Battery - Management.....	35
3	The Setting Menus.....	36
3.1	User settings.....	36
3.2	Memory management.....	Fehler! Textmarke nicht definiert.
3.3	Instrument Settings.....	37
3.4	Factory Settings (Specific instrument settings).....	38
4	Flight Memory and Data analysis.....	38
4.1	Flight Memory and Flight-Analysis.....	38
4.1.1	Logbook and Flight-Analysis page.....	40
4.1.2	Graphic display of flights in Map format.....	40
4.2	Data transfer.....	41
4.3	Data exchange via PC.....	41
4.3.1	Flight instrument options.....	42
4.3.2	Waypoints and Routes.....	42
4.3.3	Air Space (CTR's).....	42
4.4	Transfer of new software to the Competino+.....	42
5	Miscellaneous.....	Fehler! Textmarke nicht definiert.
5.1	Optional Software (additional software).....	43
6	Simulation.....	44
7	Disclaimer of Liability:.....	44
7.1	Landing in water (splashdown).....	45
8	Technical Data.....	45
9	Appendix.....	Fehler! Textmarke nicht definiert.
9.1	Altimeter.....	46
9.2	Speed.....	Fehler! Textmarke nicht definiert.
9.2.1	True or Indicated Airspeed TAS or IAS.....	46

Operating Manual COMPETINO-plus

9.2.2	Stallalarm.....	47
9.3	Navigation	48
9.3.1	GPS reception quality	48
9.3.2	Accuracy of GPS altitude	48
9.4	Flight optimisation.....	51
9.4.1	Final glide calculation	51
9.4.2	Safety altitude (Alt a. BG).....	52
9.4.3	Final glide calculation over several waypoints in between.....	52
9.5	Flight Memory and IGC File.....	53
9.5.1	Content of IGC File	53
9.5.2	New Regulations for Record flights or decentralised Competitions (OLC)	54
9.5.3	Evidence of flights Security against Manipulation	55
9.5.4	Digital Signature and OLC-Registration	55

1 Table of Contents

1.1 The Instrument

jack for
Windspeed -
sensor

SD card slot for
future applications

Not used on 6020
(charge socket 6030)

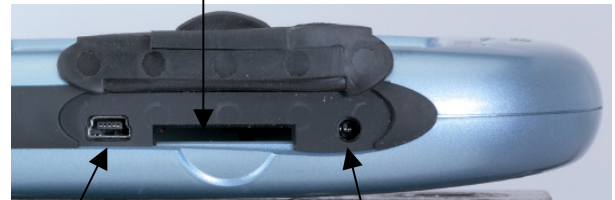

cover right side

safety cord



1.2 Switching ON and OFF the Competino+

The instrument is switched-on by pressing the **ON/OFF** key. In order to avoid unintentional switching-on, it is necessary upon display prompt „switch on ?? Press Ok“ to confirm by pressing the **OK** key. For switch-off the same key needs to be pressed for about 3 seconds and the display prompt "switch off?? Press OK " is to be confirmed by pressing the **OK** key.

1.3 Keyboard and summary of display screen.

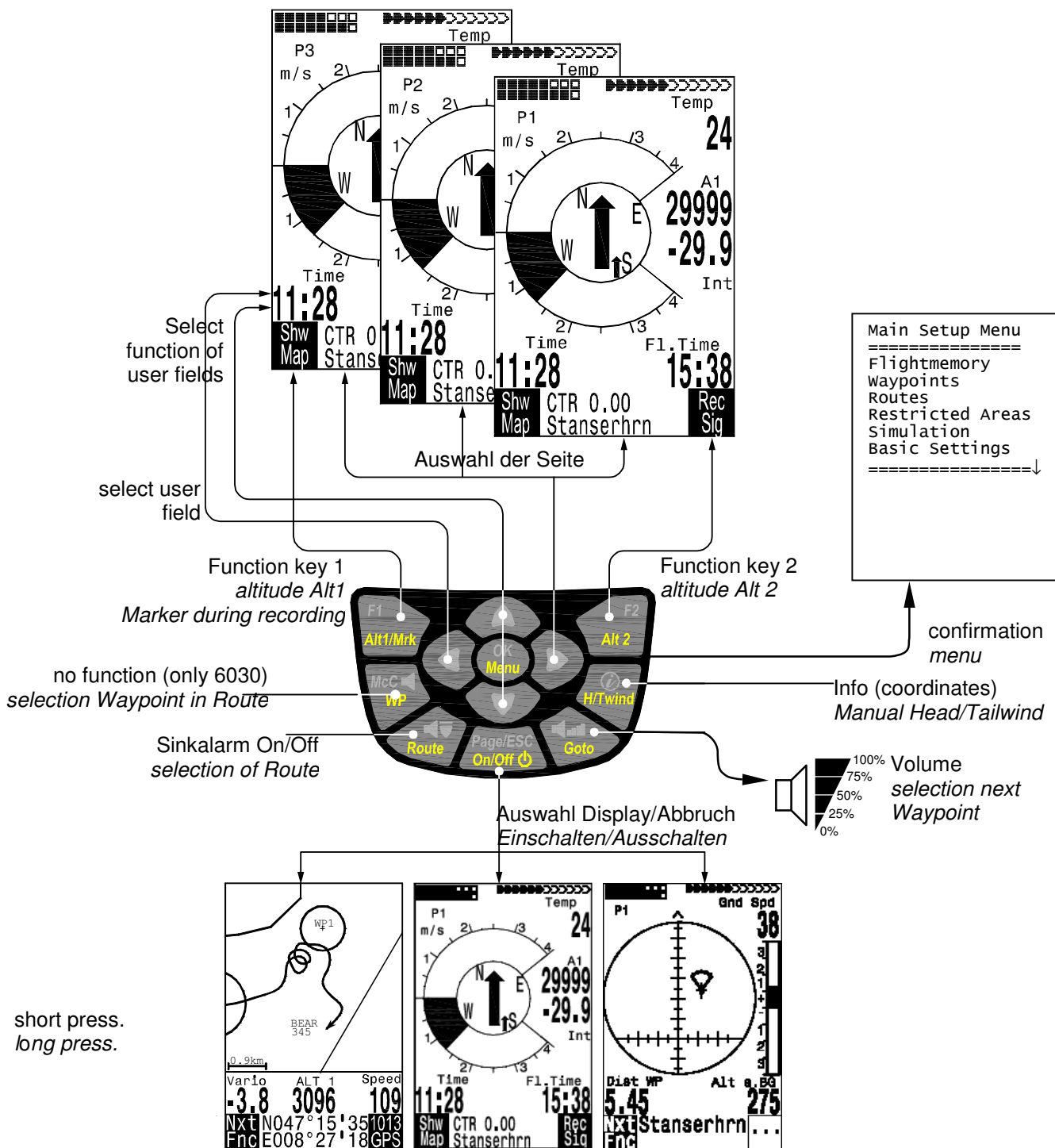

Operating Manual COMPETINO-plus

Arrow key functions in normal mode

Long press.on	F1 key	Arrow keys	F2 key
Alt1/Mrk	Alti 1013	Alti 1 ↑↓	Alti GPS
Alt 2	---	Alti 2 ↑↓	Set 0
WP	Add Wayp.	next↑pr↓ wp	---
H/Twind	---	HT wind Auto HT man. ↑↓	HT Man (Wind) HT Auto (Wind)

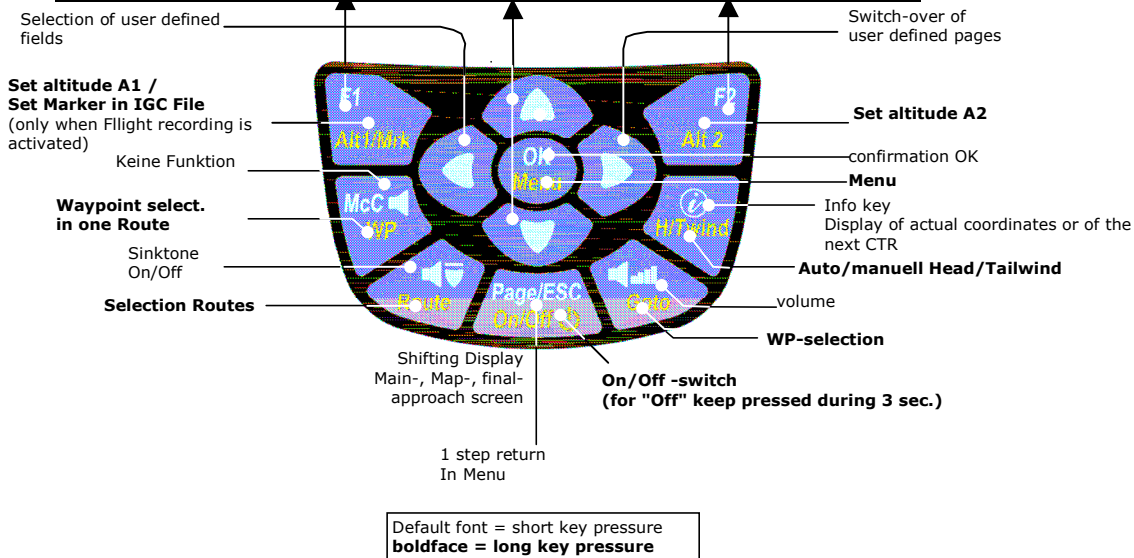

Note for switch-off: after completion of a flight the calculation of the digital signature can take up to 2 min. Please wait until the display prompt „Generating Digital Signature“ disappears and then press again the **ESC** key.

Main Display Screen

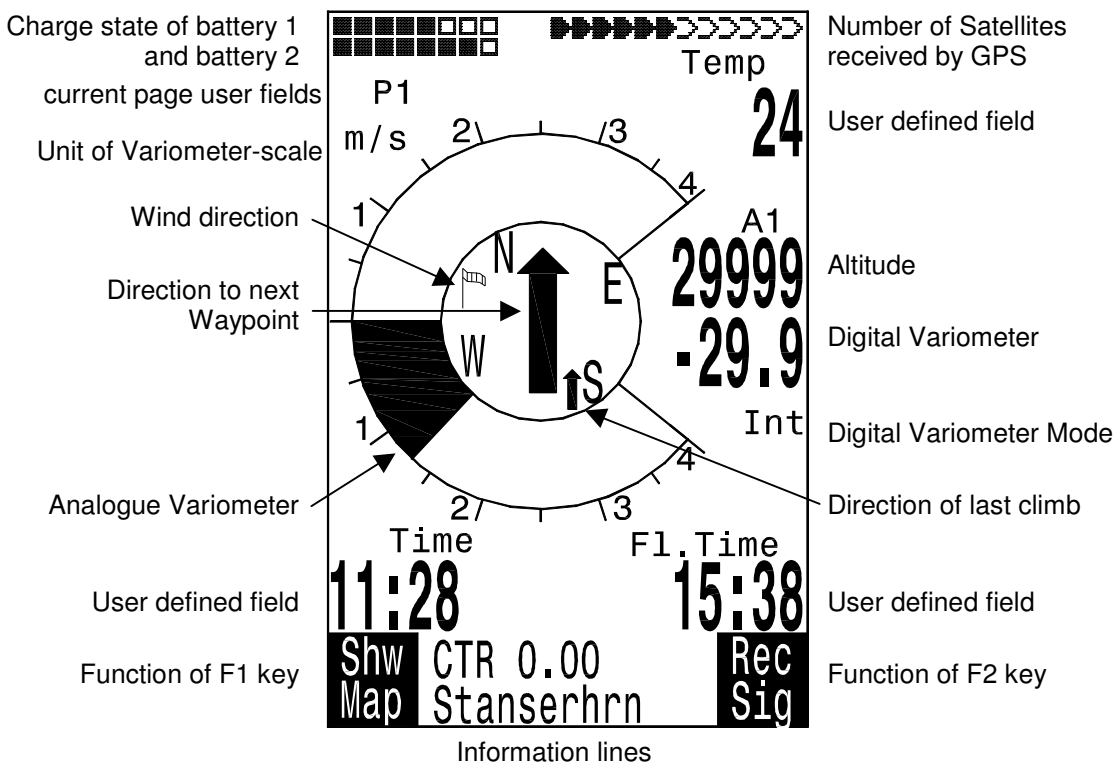

Map Screen

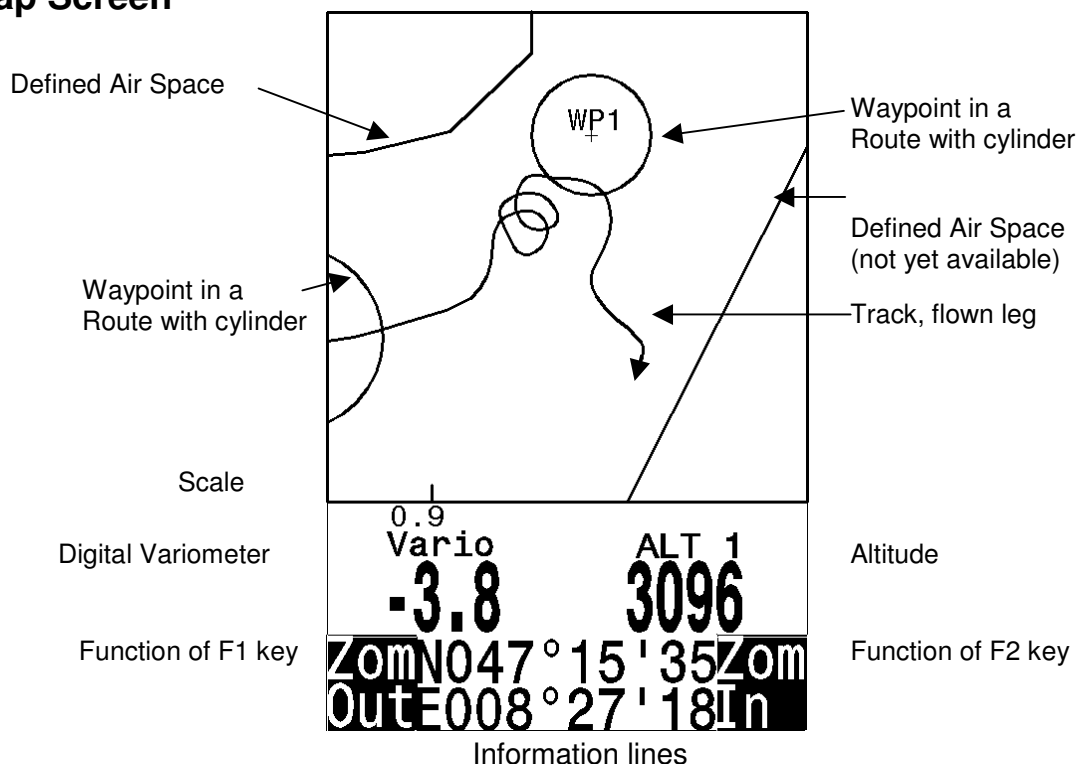

ESC is used to select the Map Mode. It is followed by the illustration of the flight track (North is located at the top!). Additionally stored waypoints are plotted with a cross and name, and the scale is indicated in the lower left part.

F2: Zoom in: The map scale is gradually increased, up to approx. 0.5–1.0 km. Thus single circles are clearly recognisable (dependent on the Recording Interval settings)

F1: Zoom out: The map scale is gradually decreased until the display screen is optimised.

OK: Return from any display back to optimised display screen.

ESC: Return to flight selection Menu

All other keys cause the track in the current selection to be redrawn.

Arrow keys:

During the flight one can blank out by use of the right arrow key all waypoints not being part of the Route. When having left the map screen and subsequently switches back, however all waypoints shall be displayed again.

During the flight the current position is shown in the centre. The screen moves by half when the current position is getting to the frame, or when one returns to map mode from any other screen display.

When viewing a flight stored in the flight memory, the displayed frame can be shifted to the top, to the bottom, or to the right or left. This function is not enabled during flight.

Note:

Each screen layout may take several seconds, depending on the amount of data. The more track points are already stored in memory, the more time for screen layout is required.

If during screen layout a zoom- or pan key is actuated, then the momentary screen layout will be cut short and start over again with the new values. Thus the desired graph will be reached speedily. The track is redrawn back from the current position. This may become important during long-lasting flights with short recording intervals for screen layout.

Final approach screen

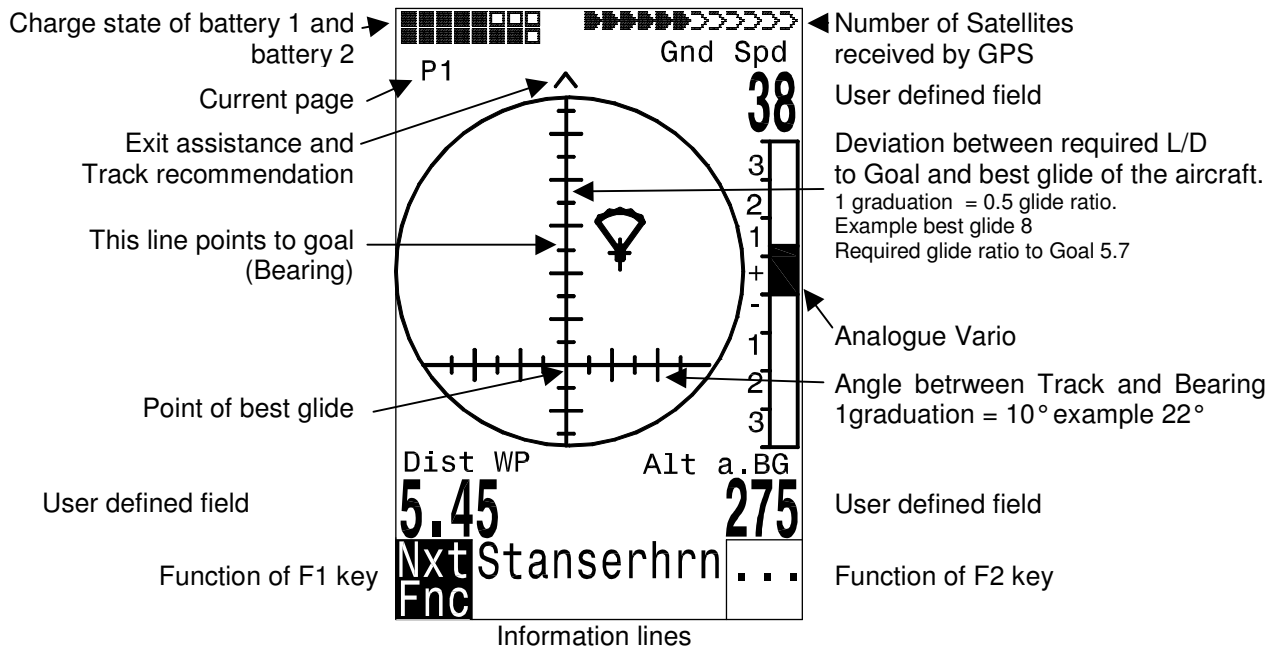

The final approach screen serves as an assistance for the final glide. It is less suitable for the normal flight. It will normally be activated in the last thermal before the goal. The horizontal scale shows the deviation between current track and bearing (direction to the goal). 1 graduation line is 10°, between 2 large lines there are 20°. The vertical scale shows the deviation between the required lift/drag ratio to the goal and the ratio of best glide of the aircraft, such as it is adjusted in the Basic Settings. One graduation line corresponds to 0,5 lift/drag ratio. There is one lift/drag ratio between 2 large lines. The example shows an aircraft with lift/drag ratio 8. The required L/D ratio to goal is 5.7. The aircraft symbol is positioned by 2.3 units above the point of best glide.

1.4 First steps

1.4.1 Prior to the first flight

	page
Entry of pilot's name, type of aircraft and number	10, 11
Selection of recording interval	38
Setting of acoustics	15
Battery check and replacement or repositioning the banks in case they are discharged	35
Entry of Waypoints	21
Determination of Routes	23, 25
If need be input of CTR's of flying area	29
Setting User fields of relevant 3 pages.	10

1.4.2 At take-off starting point

Switch-on of the instrument in time to ensure proper GPS reception quality	18
Prior to take-off check if instrument has GPS reception	18
Activate Route, if required entry of starting cylinder and starting time	23
Setting altitude A1 at altitude value of starting point. If altitude is known, this value should be entered directly. (Highest accuracy). If altitude is set using the GPS the reception needs to be of proper quality. In case satellite reception quality is insufficient, difference values in altitude of up to 100 m may occur.	12

1.4.3 For what do I have to pay attention during the flight?

For nothing! Just enjoy the flight and watch not to commit an air space violation.	
The instrument shows all important data on the large display screen at any time.	5, 29
The Routes function, the last thermal display and the Wind direction shall assist you in making the right decision.	23, 29,
Flight recording is triggered automatically, as soon as the difference in height exceeds 30m within 60s, or if speed over ground exceeds 10 km/h for 60 s.	38
The most important commands during flight are:	
ESC key for shifting to map or final approach display screen.	5
If need be, Next Prev WP, in case one is flying a Route and does not want to follow the initial order.	23
Switch-on or switch-off the sink alarm.	14
Mark an excellent thermal with the WP function „Add WP“	22
Completion of the flight is detected automatically after landing, or it can be cancelled by use of the ESC key.	
Do not forget switch-off after calculation of the signature.	38

1.4.4 Data analysis after the flight

Switch-on the instrument and connect to the PC with the Mini USB cable.	
Caution: at first the USB driver needs to be installed. This is effected automatically when installing Flychart, otherwise you need to install the driver which is compatible to your system software from the CD.	42
Select the correct interface on the flight analysis program (possible programs see chapter data transfer) or have it done by search and then download the flight from the instrument. Several programs provide direct entry to the OLC or similar online competitions.	Flychart
Download the flights regularly from the instrument to the PC and format the flight memory with <i>Del. All Records</i> in Menu „Manage Memory“. This way you are ensured to record successfully your flights at any time.	Fehler! Textmarke nicht

1.5 User defined fields

The main screen as well as the final approach screen each show up to 3 pages which are shifted by use of the ► key. Due to this feature it is possible to display nearly all the following measuring data in their correct context. The page number is displayed below the battery charge state as P1...P3.

		page
	Display remains empty	
Time of day	Time of day	17
Flight time	Flight time since take-off	38
Vario	Digital Vario	14
Altitude 1 m	Absolute altitude in m	12
Altitude 1 ft	Absolute altitude in ft	12
Altitude 2	Reference altitude, can be set to 0 user-defined	13
Altitude Sum	Cumulated gained height of the flight	13
FL (ft)	Flight level in feet. Not alterable.	12
QNH hPa	Air pressure in Hektopascal	12
Gnd Speed	Speed over ground * (= GS)	31
Air Speed	Flying speed through the air	17
Wind Speed	Wind strength *	31
Spd-Diff	Wind component (Groundspeed – True Airspeed)*	31
Track	Flight direction (course)*	19
Bearing WP	Direction to selected waypoint *	19
Dist WP	Distance to selected waypoint *	22
Dist Goal	Counted up sectors in front of the pilot up to the last WP of a Route *	28
Dist Start	Distance from starting point	28
Dist Cylin	Distance to the radius of a Waypoint cylinder in a Competition-Route	27
Dist Therm	Distance to last thermal *	29
L/D Gnd	actual Glide Ratio over ground (= Groundspeed/Sink)*	32
L/D Air	actual Glide Ratio through the air (= TAS/Sink)	32
L/D Req	required Glide Ratio over ground to reach the WP*	32
Diff. BGWayp	Safety height above the path for best Glide *	32
Diff. BGGoal	Pre-calculated height at arrival above the last waypoint of a Route *	28
Temperature	Temperature of circuit board	18

* Display only active when GPS receiver is energised.

If no data are changed after selection of a field, the instrument returns to normal mode after 10 seconds and the previous display is maintained.

1.6 Entering Text

It is possible to enter text for certain fields, as for example pilot's name, type of aircraft, aircraft ID, or in regard to Waypoints or Routes the required text on the instrument. However, this procedure is quite laborious. It is indeed much more easier to implement the text entry on the PC by use of the program Flychart 4.52 and to transfer subsequently the data to the instrument.

Text entry on the instrument is demonstrated here for the example of a Waypoint: by use of the keys ▲ and ▼ one can select a single Waypoint and alter it after pressing the **OK** key.

The 1st letter of the WP name shall be flashing. Now again by use of the ▲ and ▼ keys the required letter is selected; numbers, letters as well as a range of special characters are available.

By pressing the ► key the cursor moves to the next letter position etc. By using the  key it is possible to shift between capitals and special characters, or between minuscule and numbers. By use of the **F2** key any figure is deleted (rub out). It is possible to enter at a maximum 17 figures. When the name has been entered completely, confirm by pressing the **OK** key.

1.7 Menu Sequence

	page
Flight memory	38
Waypoints	21
Routes	23
Air Space	29
>User Settings	
>Variometer	
Basic filter	14
Digital Vario Integrator	14
Threshold last Climb	29
>Variometer Acoustics	
Acoustics Settings	15
Threshold Sink tone	15
>Speed	
Settings Wind vane	17
Stall Speed	17
>Flight Memory	
Recording Auto/Man	38
Recording interval	38
Polar Curves	31
Pilot's name	10
Type of aircraft	10
Aircraft ID	10
>Memory	
Delete flights	Fehler! Textmarke nicht definiert.
Delete WP and Routes	Fehler! Textmarke nicht definiert.
Formatting the memory	Fehler! Textmarke nicht definiert.
Delete Air Space data	Fehler! Textmarke nicht definiert.
Simulation	44
>Instrument Settings	
Display contrast	37
Language	37
Battery type	35
Time zone	17
Units	37
Coordinate format	37
Pressure sensor correction	37
Bluetooth	
SMS	
>Optional Software	43
>Factory settings	38

2 Display Screens

2.1 Altimeter and air pressure

A barometric altimeter calculates altitude from the present air pressure of the atmosphere. Air pressure will decrease at increasing height. Due to the fact that air may be compressed, the pressure decrease is not linear, but indeed exponential. The basis for altitude calculation in aviation is an international formula which defines a standard atmosphere.

In the **CINA- Standard atmosphere** the basic pressure on sea level is **1013,25 hPa** (Hektopascal) at a temperature of **15°C**. Furthermore it defines a continuous temperature decrease at increasing height of **0,65°C per 100m** ascent. Therefore is binding: a barometric aviation altimeter displays the precise altitude only if weather conditions are in exact accordance to the standard atmosphere. In practice, such analogy is more likely to be the exception!

Air weight and pressure are strongly influenced by air temperature. If temperature deviates from standard atmosphere, the display of altitude calculated as per the international formula is no longer correct. The altimeter displays during summer, when temperatures are higher, indeed altitude parameters which are too low, and during the winter it is exactly the contrary! Flying at lower temperatures is effectively done at lower altitude, and at higher temperatures flight altitude is higher than the altimeter displays! The deviation of 1 °C per 1000 height meters induces approx. 4 m error. (This empirical formula is valid for up to 4000m!)

If you fly during summer through 2000 height meters in an air mass being too warm by 16 °C compared to standard atmosphere, the altimeter will then display $2 \times 4 \times 16 = 128\text{m}$ difference in altitude under real height! Based upon the internationally determined altitude calculation with standard values, this display error caused by air temperature shall not be rectified by the instrument.

Air pressure changes in relation to weather conditions. In order to compensate for display fluctuations, an altimeter always needs to be gauged. This means that the altimeter has to be set precisely before take-off for any flight to a well-known altitude value. Caution: the atmospheric pressure may change during the timeline of one day up to five Hektopascal (for ex. cold front). As a result this is after all the equivalent of more than 40 meters height difference.

There is another possibility to gauge the altimeter which is to enter the current QNH pressure value. The QNH (Question Normal Height) applied in aviation matches the current local air pressure, as it would be at sea level, so that the altimeter would indeed display 0m.

Due to this process the local pressure data recorded by the various measurement stations is area-wide comparable, irrespective of the geographical height.

The QNH-value is subject to be continuously updated and may be read in the flight weather report, or required by radio from airfields, or by enquiry on the Internet.

The instrument provides 3 altitude displays.

2.1.1 Altimeter A1, absolute Altitude

A1 is always the altitude above sea level (large display in upper part of display screen).

Altitude A1 is originally set by the manufacturer to show the correct altitude of user's location if air pressure at sea level is 1013 hPa. Bearing in mind that this only happens infrequently, the displayed altitude A1 should be gauged before each take-off to the actual, true height at location.

Correction of altitude A1:

Long pressure on **F1** ⇒ will generate the message Mod Alt1 ↑↓ in the lower information line.

Pressing the ▲ key will increase the displayed altitude, the ▼ key will decrease altitude. Due to this adjustment the air pressure display will also change. This air pressure value (QNH) is always related to the height at sea level.

If the user does not know the altitude of his present location, he may obtain the data by fading in the „User Field QNH“ and, using the arrow keys, by changing the altitude value until the QNH matches the actual QNH as per weather forecast.

If the GPS system receives satellites, the GPS-altitude is applied as Alt1 by pressing the **F2** (Alti GPS) key. If there is no GPS reception, it is possible to set the altitude Alt1 by use of the function key **F1** (Alti 1013) to a value which complies to QNH pressure of 1013 hPa.

If the altitude A1 of any given landing place is set to 0m, then after take-off there will of course always be displayed the altitude above this location. The related air pressure (QFE) is the real present air pressure at this place in hPa, which differs of course from QNH, which is the pressure at sea level, according to the difference of altitude.

Within the user selectable fields it is also possible to choose altitude A1 in ft. This information is important when being in contact with the air traffic manager in Restricted Areas.

Furthermore it is possible to choose FL (ft) in the user selectable fields. This value is an altitude display in feet for the Flight level (FL). This feature is not adjustable and is always related to a QNH value of 1013 hPa (air pressure at sea level). This display is particularly important for pilots of microlight aircraft to whom is assigned a Flight Level by air traffic-controllers during flights in Restricted Areas.

2.1.2 Altimeter A2, relative altitude

A2 (within the user selectable fields) is a reference altitude, it can be modified by use of the arrow keys ▲ ▼.

Correction of altitude A2:

Long pressure on **F2** ⇒ will generate the message „Mod A2 ↑↓“ in the lower information line.

By use of the arrow ▲ ▼ keys it is possible to set the height difference, or to set with brief pressure on **F2** (SET 0) the height difference to 0.

2.1.3 Altimeter A3, cumulated altitude

A3 (within the user selectable fields) sums up the total height meters gained during one flight. For thermal flights this height is dependant on flight time. If several pilots complete the same flight task, then the one who had the least gain in height (A3) would have been the best to accomplish the task.

A2, A3, FL or QNH can be selected within the user selectable fields.
(see page 10).

2.2 Variometer functions

2.2.1 Analogue Vario

The most important indication for a non-motor driven aircraft is without any doubt the Variometer. It displays the vertical speed in meter/second and informs the pilot about the actual climb or sink rate.

It is only possible for the pilot by using the Vario (and its accompanying acoustics) to determine the most efficient thermal climb, and in the opposite situation, to recognise when he is sinking too rapidly in downwind and should leave them at best speed.

The scale of the analogue display is 0,2 m/s. The range of the first scale extends from 0 up to +/- 4 m/s, thereafter the scale display switches automatically and the range of the second scale extends from 4... 8 m/s.

The response characteristics of the analogue Vario and of climb acoustics can be set within a wide range. In order to simplify the settings, Brauniger has determined 5 basic filters which can be set by the Flychart program to particular requirements when using a special command.

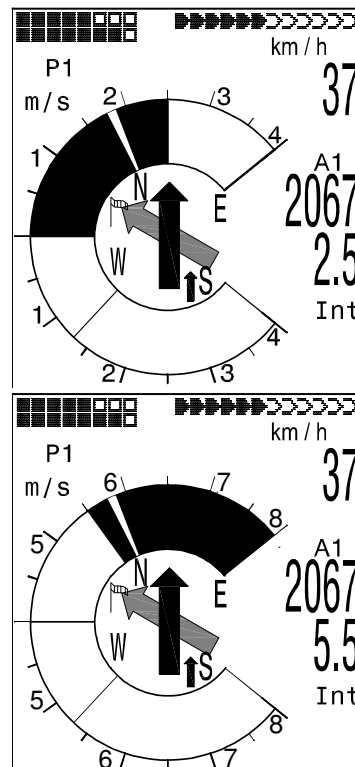

Setting of basic filter:

Main Setup Menu ⇒ *User Settings* ⇒ *Variometer* ⇒ *Basic filter..*

The following chart is presented for information purpose only to pilots who have already flown with the 5020 instrument, in order to facilitate comparison with the previous values.

Filter No.		Filter 1 (Pre-filter) Number Samples (Sample rate 0.2s)	Filter 2 (Vario filter)
0 Default	Default: Corresponds to previous setting 5020	2 Samples	1.2s
1	Previous setting, high filtration	5 Samples	1.2s
2	Highly filtered	8 Samples	1.8s
3	Minimally filtered (Air very quiet, Table,)	5 Samples	0.8s
4	New constantly at Vario 0	3 Samples	0.6s

2.2.2 Digital-Vario Average- or Netto-Vario

The Digital Vario has a scale of 10 cm/s and an extensive measuring range of up to +/- 100 m/s. It is therefore also appropriate to display the vertical speed for parachutists during the jump.

It may be provided with a time constant from 1 ... 30 s in the Set-Mode under "**Variomode**" as average value-Vario (also called integrating Vario). This feature is useful to provide a more settled Vario display inside a rough thermal. Integration time should be selected more longer in accordance to the thermal's roughness.

2.2.3 Acoustics and Volume Level (Sound)

The Menu Climb acoustics facilitates the versatile setting possibilities of the Competino+ Vario – Acoustics. This feature enables a rapid and easy adaptation to the pilot's requirements. By short pressure on the **Goto** key the volume level will increase each time by 25%. The adjustable sound levels are: 0 - 25% - 50% - 75% - 100% - 0. The selected value is displayed on the information line and confirmed with a short beep or double-beep.

Automatic volume control: with the basic setting levels 25 50 and 75 % the volume level will be slowly increased automatically, once the airspeed exceeds 40 km/h. However, it is impossible for the volume level to exceed 100%.

Following settings are possible in the Setup-Menu under *User Settings* ⇒ *Vario Acoustics* ⇒ *Acoustics settings*.

The climb tone is a frequency modulated beep tone whose pitch and beep tone sequence increase rhythmically at increasing climb rate. The pulse/pause ratio is 1:1.

Asc, F

Basic Tone pitch is the frequency audible at starting climb tone.

Mod.

Increase Tone pitch the interrelation may be seen on graphic below.

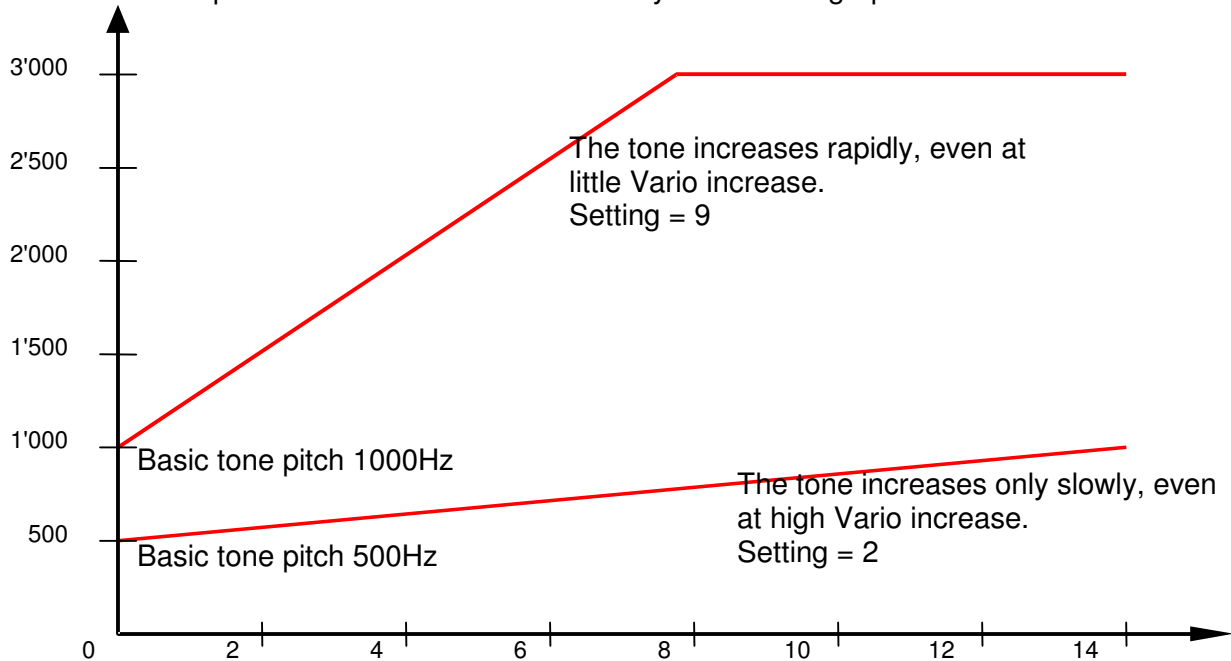

SinkF

Basic Tone pitch

Tone pitch at starting Sink tone. The Sink tone is continuous and is heard with deeper sound pitch at increasing sink speed and is slowly increasing in frequency when approaching rising air. The basic tone pitch of sink acoustics may only be set equally to the basic tone pitch for climb acoustics.

The Sink tone may be switched-off by briefly pressing the **Goto** key, and can also be switched-on again; then the analogue Vario display would show the relevant threshold. Starting point of sink tone is set *Main Setup Menu* ⇒ *User Settings* ⇒ *Vario Acoustics* ⇒ *Sink tone threshold*

damp

Dampening

The Variometer value is recalculated every 0.2s. In case of rapid Vario changes and setting of quickly increasing tone pitch, this may possibly result between two calculation phases in a quite important modification of tone frequency. The ear perceives this incidence as a kind of fast “piano effect”. In order to diminish this effect, a damping feature may be fitted. Then rapid tone pitches are honed in the frequency. As a result, the Vario sound has a smoother response.

Pit.

Beep intervall

See graphic

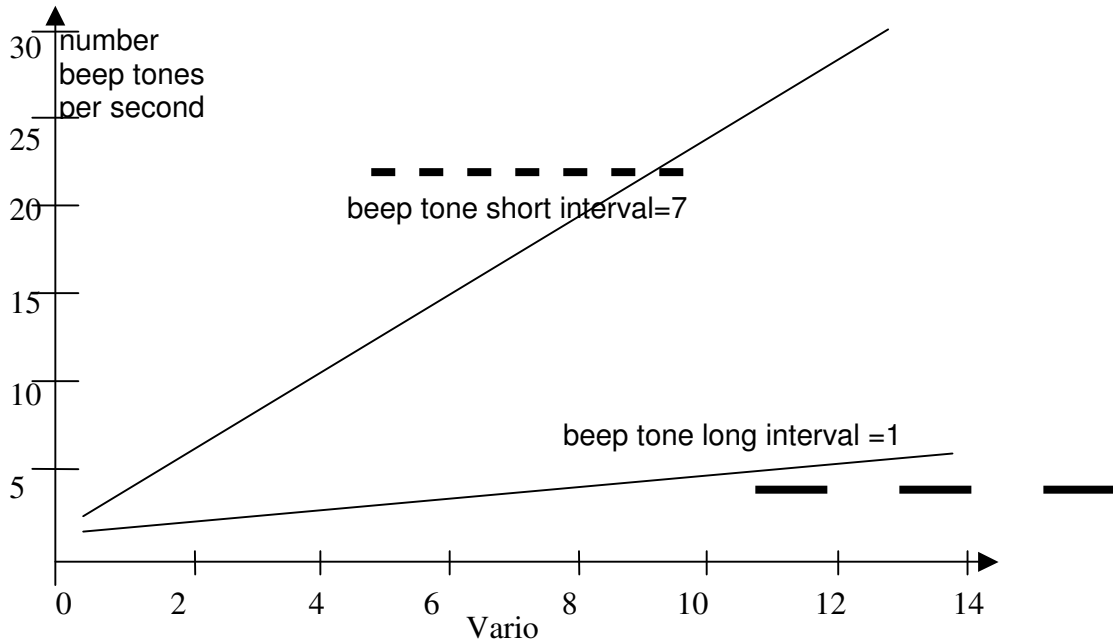

Main Setup Menu ⇒ User Settings ⇒ Vario-Acoustics ⇒ Sink tone threshold .

The Sink tone is continuous and is heard with deeper sound pitch at increasing sink speed and is slowly again increasing in frequency when approaching rising air.

Starting point

The starting point of sink acoustics can be selected just as in climb acoustics. The threshold can be set by use of the ▲ ▼ arrow keys.

During flight the Sink tone can be switched-on or switched-off by short pressure on the **Goto** key. Then one can see upon switch-on the selected starting point in the analogue Vario scale. Switch-off is just confirmed by a short beep of the key.

Main Setup Menu ⇒ User Settings ⇒ Vario-Acoustics ⇒ Vario Climb threshold

Starting point

In order to avoid the climb acoustics get started with immobile aircraft, for ex. at take-off area, or at only slight climb, the climb acoustics starting point can be set in the range from 0 cm/s up to 20 cm/s. Depending on the selected filter type, when climbing, the Vario shall now activate vigorously or slowly

negative value, if it is at the West. Time zones with 0.5h UTC Offset are also adjustable.

These settings are effected in *Main Setup Menu* ⇒ *Instr. Settings.* ⇒ *Time zone*

Notice: all internal calculations of the instrument are made in UTC (Coordinated Universal Time). The local time is just used as „Time“ display and calculates simply the UTC plus or minus the UTC Offset.

The local time is also binding for the take-off time at Competition Routes.

2.5 Temperature

The instrument Brauniger Competino+ needs a temperature sensor for the temperature compensation of sensors, as well as for the automatic display contrast control.

Temperature reading is possible in degree Centigrade or Fahrenheit.

Main Setup Menu ⇒ *Instr. Settings* ⇒ *Units.*

Caution: the sensor measures the circuit board temperature. The inside temperature of the casing may be higher or lower than the ambient air temperature, especially when the instrument is exposed to direct sunlight.

2.6 Navigation

Navigation activities without operating GPS-Receivers is unthinkable these days.

Indeed a chain of satellites is orbiting the Globe. It provides the possibility to determine

worldwide one's own position very precisely, if min. 4 satellites are received simultaneously.

The Brauniger Competino+ computes various indicators via the positioning feature by GPS.

2.6.1 Assessment of reception quality

The Competino+ is fitted with a 16-channel GPS-Receiver which is featured with lesser power consumption and also a significantly shorter Satellite detection time.

Accuracy of position is between 7 to 40m. As an average one may assume approx. 20 m.

Normally the instrument recognises its position under unobstructed view conditions after maximum 1 to 2 minutes. If the receiver is switched-off for a short time (less than 2 hrs.), the time for new position finding is less than 10 seconds as a rule. Buildings, mountains or thick forest affect reception quality of the receiver. Therefore, one should always look for the best possible visibility around and the antenna in the casing should be pointed upwards if applicable. In particular when mounted on the steering holder of the hangglider, we recommend not to have the instrument fixed under the pilot's head on the middle of the basis, but indeed sideways. In this position the Competino+ should not have more than 45° deviation from horizontal position so that the antenna points upwards.



Because the receiving intensity of the Satellite signals is only approx. 1/1000 of mobile radios, any radio equipment and other disruptive factors (like notebooks) should be operated as far away as possible from the Competino+.

The number of received satellites is shown on the upper right side of the bar scale.

The longer the bar, the more precise is the reception quality.

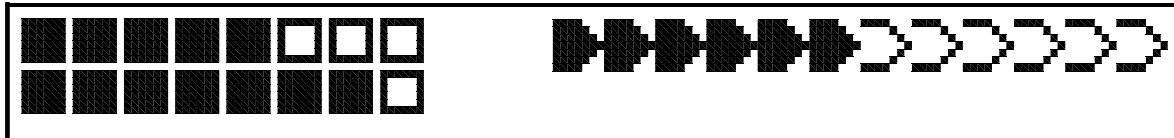

As soon as the instrument has sufficient GPS reception after energising, the date and time of day is recorded into the internal memory. This action is signalled by the instrument with a slight beep tone.

2.6.2 Compass and Flight Direction

In contrast to a normal magnetic compass which is oriented to the magnetic force lines of the Globe, the GPS compass can show the direction only when the user moves about. However, it has the advantage that it is not subject to any grid deviation and does not show any deviation as a result of iron or any magnetic material either. Its zero point always corresponds with the true geographic north (=0 or 360 degrees).

The course, that is the flight direction (= Track), is calculated from a series of positions. If the user remains stationary at the same location, then the course and compass needles are undefined. The exact course (this is the direction in which the user travels over ground), is always at the top of the compass, but can also be read in the display "*Track*". When circling in a thermal the compass rose only appears to turn; in reality the needle does not move; it's the casing along with the aircraft, which moves around the rose.

2.6.3 Track und Bearing

The Track is defined as the direction of movements of the aircraft over ground.

The geographic true North is always 0 or 360 degrees (East = 90, South = 180, West = 270 degrees).

As the bearing is designated the direction (according to the system described above) to a selected waypoint seen from the viewer.

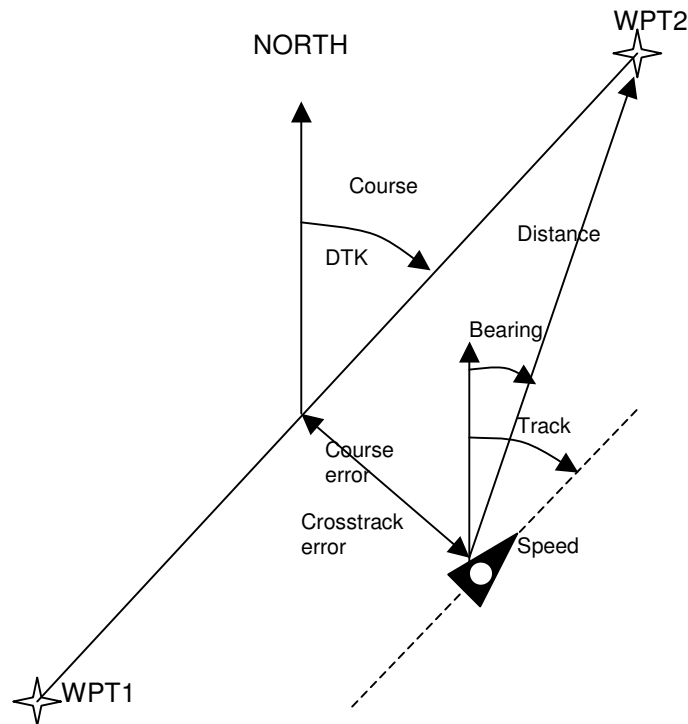

Caution: Track or Tracklog is also called the sequence of recorded positions during one flight.

2.6.4 Waypoints and co-ordinates

A waypoint is any single point on the earth's surface that you would like to go to. The Competino+ can save up to 200 different waypoints. Each waypoint can have up to 16 characters, e.g. "Fiesch Airfield". In determining the waypoint, it is also necessary to enter the altitude, i.e. "1123" meters (always above sea level). We now only need the positioning of waypoint on the earth's surface. For this purpose the Competino+ utilizes the geographical map system named **WGS84** (World Geodetic System 1984). This reference system assumes that latitude is measured from the equator to the North Pole with 90° N, and to the South Pole with 90° S. Longitude is measured from the Greenwich zero meridian (near London), East is counted positive and West is negative, up to +/- 180°.

The Competino+ also understands waypoints entered according to the previous norm, introduced by Bräuniger: **3 letters and 3 numbers**. Example: **FIE112** indicates a waypoint with the name **FIExxx** and an altitude of **1120** meters above sea level.

In Basic Settings / Coordinate Format the data entry format is selectable between:

- 1) Degrees Minutes Decimal places of Minutes (dd°mm.mmm) (Factory setting)
- 2) Degrees Minutes Seconds (dd°mm'ss")
- 3) Degrees Decimal places of degrees (dd.ddddd)
- 4) UTM (a grid system with 1 km raster in both NS and also in EW direction)
- 5) Swiss Grid

Basically one should always select the first possibility (=factory setting), because only this format is using exactly the same calculation format as the GPS receivers do. With all the other formats rounding errors could sum up to 20 m.

Computing is only done with the WGS84 system. Differing Geodetic systems can no longer be selected.

2.6.4.1 Waypoints - alter, delete or insert

In this position of Setup-Menu the waypoints may be managed. **Waypoints may also be set comfortably on the PC by use of the „Flychart 4.52“ PC-Software and be transferred via the PC-interface to the instrument.**

Using *Menu* ⇒ *Waypoints* prompts a list with the waypoints stored in memory. If this list contains more than the visible 6 waypoints, a down arrow ↓ at the right lower edge of the list warns that more pages are to follow. To scroll down page by page, press the ► key, now WP 7 ... 12 are displayed etc.

Using the keys ▲ and ▼ it is possible to select an individual WP for editing after pressing the **OK** key.

The 1st letter of the WP name will blink. Again with the ▲ and ▼ keys the required letter is selected; there are numbers, letters, as well as a set of special characters to choose from. By pressing the ► key one moves forward to the next letter etc. With the **F1** key one can shift between capitals and minuscule. With the **F2** key one single character is deleted (Rub out). You can enter a maximum of 16 numeric.

Once the name has been entered completely, confirm by pressing **OK**. Now the waypoint altitude will blink, requiring any alterations. With the ▲▼ keys the altitude value is entered and confirmed by pressing **OK**. Now the position of WP is next. At first the latitude is entered in degrees and confirmed with **OK**, after that the minutes, confirmed by **OK** and then the decimals of the minutes. The same procedure is applied for the longitude. Holding the key down for a longer moment, changes the values to be set faster.

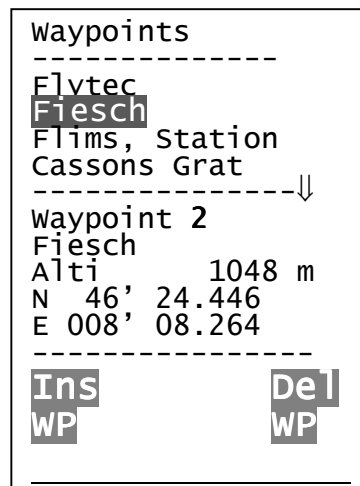

Delete Waypoints:

The selection of WP's to be deleted is effected with the ▲ and ▼ keys. Pressing the **F2** key (Del WP) enables the deleting function, for data safety the Competino+ is asking again: "Delete Waypoint?". The reply "Yes" or "No" is at choice, but it is also possible to discontinue the deleting procedure by use of the **ESC** key and return to one level before.

Insert Waypoints:

Pressing the **F1** key (Ins WP) enables this function. Entering waypoint names, altitude and position is operated by following the same scheme as described above. After confirming all entries with the **OK** key, the new WP is inserted in alphabetical order to the list. In total up to 200 WP can be saved in the Competino+ instrument.

Caution: after inserting the new waypoints, (for ex. entry of a new Route) these can be used only, if in between one has switched back to the normal flight mode by pressing **Esc**. Furthermore, the Route into which the new waypoint should be inserted must not be active. Therefore, first change into route selection by prolonged pressing of the *Route* key and deactivate the Route with the help of the **F2** key (Cancel Route).

The more waypoints there are in memory, the more slowly becomes the navigation in the Main Setup Menu, because the list is always tabulated again in the background.

2.6.4.2 Display of actual Coordinates

If the Competino+ receives satellites by GPS-Receiver, the actual position is displayed by short pressing of the **i/H/Twind** key in the instrument's information field. After 20 sec. the previous display screen will automatically reappear. This function is useful in relaying

your location after landing to some person who will retrieve you from there.

The coordinates are also displayed when entering a waypoint using the key **McC/WP** ⇒ **F1 AddWp**.

2.6.4.3 Memorising the actual Position

It may happen from time to time that the current position should be saved as waypoint. For this purpose the **McC** key should be pressed during 3 seconds and subsequently the key ⇒ **F1 AddWp**. In response a beep will chime and the momentary coordinates shall be saved in the memory as a waypoint.

As name for the waypoint the Competino+ uses the letter **M** (for marker) and after it the actual date and the time of day in UTC.

Example: M.22.04. 11:16:49 stands for 22nd April at 11 hrs. 16 min. 49 seconds (UTC).

Naturally this name of waypoint may be changed later into a more meaningful name, for ex. "Fiesch Airfield".

2.6.4.4 Distance to Waypoint

Only in case a waypoint has been selected manually with the **"Goto"** function, or automatically with the **"Route"** function, the horizontal distance seen from the viewer to the waypoint is displayed. The scale is 10 m (for distance under 10 km) otherwise 0,1 km.

Also when the waypoint is used as turning point in a competition, it is always the distance to the centre of the cylinder which is displayed.

2.6.4.5 Goto – Function

Prolonged pressure on the **Goto** key switches the lower half of the instrument into Goto-Mode. This function allows to search for a waypoint stored in the memory of the Competino+ and to choose it for a flight to goal. At the same time the next waypoints are listed in the order of shortest distance to the user.

The number behind the WP name indicates the distance in km. If a WP is selected with the ▼ key, it can be acknowledged by pressing the **OK** key. The Goto function can be deactivated with the key **F2 (Can Wp.)**.

Lead: The large directional pointer of the compass points directly to the goal. If a strong cross wind is encountered on the way to goal, the right **correction angle** can be found by carefully changing the direction of flight against the wind, until the directional pointer in the compass rose points precisely upwards. In that way it is ensured that the flight path over ground is in a straight line to goal and thereby the shortest one.

The so-called *pursuit curve* is thus avoided.

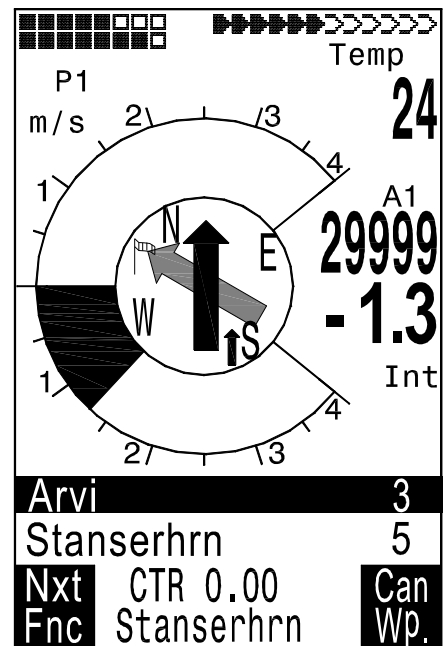

2.6.4.6 Altitude over the path of best Glide: Alt a. BG

While circling upwards before approaching a WP this altitude will show 0, when the pilot should be able to reach the goal by flying at the best glide speed. Every meter above that means a greater safety margin. As soon as „Alt a.BG“ shows a positive value, this field is displayed by inverse mode. See chapter 2.7.5 Safety Altitude over path for best glide. Safety altitude over the path of best Glide – Diff.BGWyp and Diff.BGGoal page 32.

2.6.5 Flying Routes

A route is an arrangement of various waypoints. The waypoints used on a Route need to be saved in the unit's memory. Whilst in the Goto-Function the next WP has to be selected each time from a list by prolonged pressing of the **Goto** key, when flying Routes it is possible to switch forward by briefly pressing the key **▲** (*next WP*) or **▼** (*previous WP*) if one is inside the WP Menu. The WP Menu is enabled by prolonged pressing of the **McC/WP** key.

It is only possible to select Routes which contain at least one waypoint. Selection of a Route is effected by prolonged pressing of the **Route** key. Each Route should also be assigned a name, for ex. „Cassons Grat“.

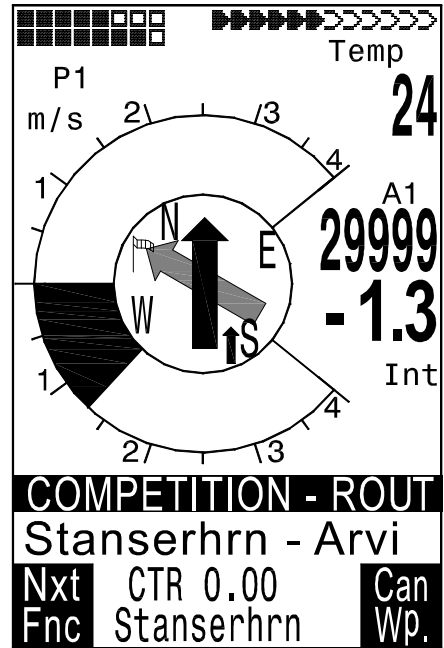

In the centre of the compass rose a thick black arrow points to the direction of the next waypoint. The direction to the next but one waypoint is illustrated in shaded mode.

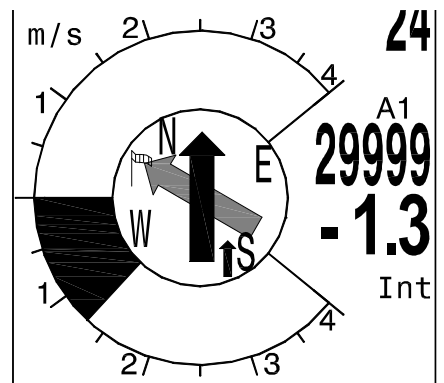

2.6.5.1 Routes: Set – Delete – Alter – Copy

Main Setup Menu ⇒ Routes gives access to the list of saved Routes. (Max. 20 Routes). From this list any one of these Routes can be selected by using the **▼** or **▲** keys.

Routes may also be set comfortably on the PC by use of the PC-Software „Flychart 4.52“ and be transferred via the PC-interface to the instrument.

To delete select the key **F2** (Del.-Route), or to alter select the key **OK**. However, by pressing the key **F1** (Ins. Route), a new Route can be created.

Setting a new Route

After pressing the key **F1** (Ins.Route), at first a name has to be entered for the Route. The cursor will blink on the first letter of the word “Xxxx”. By using the **▲** or **▼** arrow keys one alters each to the desired letter. By using the **►** key one proceeds to the second letter, enters the changed letter, and so forth.

By pressing the **OK** key one concludes the entry of the Route name.

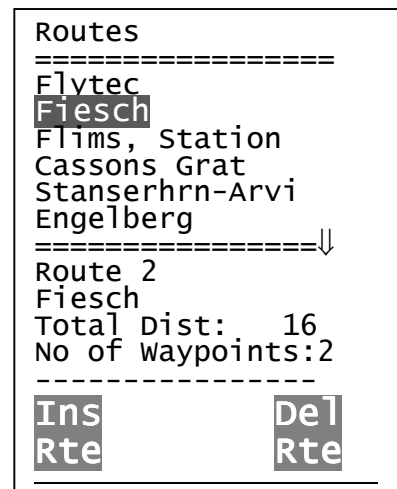

Now at this point the individual waypoints need to be inserted into the Route.

After pressing the key **F1** (Ins.Wayp), the list of available waypoints will appear in the bottom half of the screen in alphabetical order. At the same time one will see the prompt: "Select Waypoint No1." Again by using the **▲** or **▼** keys one has to search for the 1st WP and it is added to the Route by pressing the **OK** key. This is indicated in the upper half of the screen. By pressing the key **F1** (Ins.WP) again, one can select the second waypoint and add it to the Route with the **OK** key etc. The highlighted waypoint (now offset in black) in the Route is always the last one entered, which means that the function "Ins.WP" will set the next WP to be entered after the one highlighted in black. If e.g. one wants to insert an additional waypoint after WP1, then you highlight WP1, press the **F1** key (Ins.WP); then the prompt "Select Waypoint No 2" appears.

If you notice, for example, that Waypoint No. 4 must be changed, then you select and delete it and insert a new one after the existing WP3 by pressing the **F1** key. Again the list of available waypoints appears and the request "Edit Waypoint No 4". After selecting and pressing the **OK** key, the old waypoint is replaced by the newly chosen one.

If one wants to delete a waypoint from the Route, it is marked and completed by pressing the key **F2** (Del. Wayp). The waypoint is then deleted from the list without any additional query.

Altering a Route

You select a route to be changed with the **▲** or **▼** keys and confirm with **OK**. The Route name is changed first. If this is not what you want, then it is sufficient to press **OK** again in order to get access to the waypoints of the Route. As described in the last paragraph, additional waypoints can now be added or deleted.

Deleting a Route

You select the route to be deleted with the **▲** or **▼** keys and confirm by pressing the key **F2** (Del.Route). For data safety the Competino+ inquires once again: ("Delete Route?") which is to be answered with Yes or No.

Copying a normal Route as Competition-Route

Each one of the existing Routes may be copied into the memory of Competition-Routes. For this purpose the required Route is to be marked and followed by long pressing of the **McC** key. **Please note that after this entry the start cylinder, radii and start time need to be set separately, because all cylinder radii are reset to the default value of 400 m.**

2.6.6 The Competition-Route

In contrast to the routes described above, the Competition-Route contains waypoints which **are mandatory to be reached**; for example turning points in competition or FAI-record flights, or performance flights. The regulation, which only recently came into effect in documenting distances flown, fully relies on the recording of GPS-Receiver position data (Tracklog points).

It is only when flying Competition Routes that the pilot will be warned by an acoustic alarm when approaching his waypoints or when leaving the start cylinder and that the unit switches automatically to the next waypoint. Call-up of the Competition Route is effected by prolonged pressing of the **Route** key and confirmation by **OK** key. The Competition-

Route, once it has been activated, remains enabled even after switching-off the instrument. It can only be disabled by prolonged pressing of the **Route** key followed by **F2 Cancel Route**.

Instead of the previous photographic sectors the pilot only needs to reach a predetermined distance to the turning point. It is also called the entering flight into the cylinder.

This distance, or cylinder circumference can be set in *Main Setup Menu* ⇒ *Routes* ⇒ *COMPETITION-ROUTE* for each waypoint separately within the range of 20 m up to max. 200 km. **In Default- or factory settings a cylinder circumference of 400 m is pre-set.**

Setting of the differing cylinder radii, of start time, the flight task (=Entering or Exiting the start cylinder) is effected upon data entry of the Competition-Route.

Beside the automatic shift to the next WP, the pilot can also shift manually by use of arrow keys ▲ or ▼ to the next or to the previous WP.

COMPETITION-ROUTE	
=====	
Flytec	0.4S
Fiesch	0.4
Flims, Station	0.4
Cassons Grat	0.4
Stanserhrn-Arv	0.4
Engelberg	0.4
=====↓	
wp1/6 in Route	
Flytec	
Total Dist:	16
Radius [m]:	2
Start	14:15+05min
Gates 02	EXIT

2.6.6.1 Flying Competition-Routes

Because the GPS-Receiver of the Competino+ identifies its new position every second, it takes only this one second to inform the pilot about his crossing of the turning point cylinder circumference or that the time has come to leave the start cylinder. In this case a long, unmistakable tone sounds during 2 seconds (**CMP-Sound**) and the instrument switches automatically to the next waypoint of the Route. Independent of what recording interval for storage is used during a standard flight, it is anyway guaranteed that several Tracklog points are saved in the memory of the Competino+ at one second intervals when crossing the cylinder circumference.

Usually the start cylinder is in first position of the Competition-Route. (However this is not mandatory). If during setting or changing the Competition-Route after marking a waypoint the key **McC** is pressed, the letter "S" for **Start-Cylinder** appears behind the WAYPOINT name. The "S" disappears if the same key is pressed again. Only if a waypoint is marked with "S", it is necessary to set also a Start time and as task ENTER or EXIT. If no WAYPOINT has been designated as Start-Cylinder, the pilots are not bound to observe a start time and the automatic shifting to the next WAYPOINT is effected, as soon as the pilot is present inside the cylinder.

If however in a competition a start cylinder is predetermined, the valuation starts as soon as the start time is reached under these conditions:

- Startmode EXIT:** if the pilot leaves the cylinder from inside to outside.
- Startmode ENTER:** if the pilot crosses the Start cylinder from outside to inside.

It is possible to choose several start gates.

EXIT Cylinder

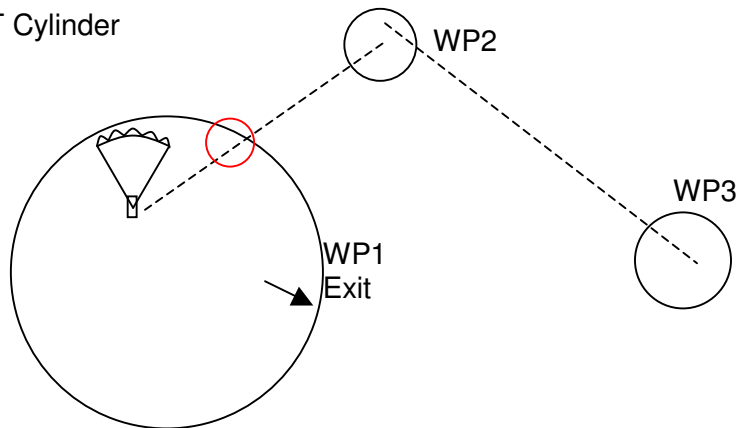

The signal „waypoint reached“ is audible as soon as the start time is reached and the pilot is inside the start cylinder. It will also sound if the start time is positive and the pilot crosses the start cylinder circumference from outside to inside. In both cases the next active waypoint will be enabled, in this case Waypoint2. All calculations and the direction arrows are now pointing to Waypoint2

If the pilot decides to take the next start gate, he must press the Prev WP ▼ key. (Select with key **MCC** the Sub-Menu Prev/Next WP). The instrument then enables WP1 again and will increment the start time by the preset difference. When the last start gate is reached, the start time will no longer be increased after pressing of Prev. WP ▼.

Caution: for EXIT cylinder it is required that the first waypoint after the start cylinder is outside of the start cylinder!

ENTER Cylinder

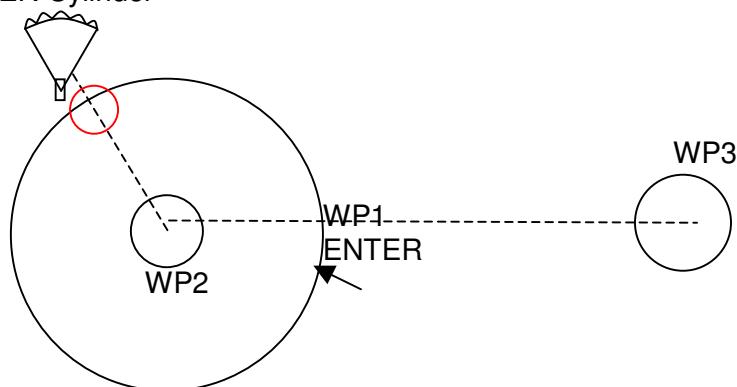

The signal „waypoint reached“ is audible as soon as the start time is positive and the pilot is crossing the start cylinder circumference from outside to inside. In this case the next active waypoint will be enabled, in this case WP2. All calculations and the direction arrows are now pointing to WP2

If the pilot decides to take the next start gate, he may press the Prev WP ▼ key. (Select with key **MCC** the Sub-Menu Prev/Next WP). He can do this regardless if he is present inside or outside of the cylinder. The instrument then enables WP1 again and will increment the start time by the preset difference. When the last start gate is reached, the start time will no longer be increased after pressing of Prev. WP ▼.

Caution: for ENTER cylinder it is required that the first waypoint after the start cylinder is inside and usually in the centre of the start cylinder!

During a flight the pilot can see on the Info-field display via count-down how many seconds / minutes are left before opening of the Start line. At the same time he can read in the display „Dist to WP“ and “Dist.Cyl” if he is inside or outside of the start cylinder. If the pilot has flown out of the WP-Cylinder and the instrument has shifted to the next waypoint, it is possible by pressing the ▼ arrow key to switch back at discretion to the previous waypoint, and by pressing the ▲ arrow key to shift again to the next waypoint. This is useful when a pilot, after having left the start cylinder, has decided to fly back and to restart at a later time.

Also during the flight in Competition-Route, it is possible by using the *Goto-key* (prolonged pressing) to call-up additional waypoints (thermal sources), sorted according to their distance from the pilot. The waypoints being part of the Competition-Route are marked with an asterisk in the displayed list; this means it is mandatory that they need to be approached. Even in case a waypoint not belonging to the Route has been called-up, the alarm remains enabled when entering the cylinder of the waypoint belonging to the Route. With the F2
AR 2 key it is possible to toggle back and forth between the waypoint of the Competition-Route and the other waypoint.

After completing a flight task, the waypoints belonging to the Competition-Route will be listed in the data transfer to a PC under the header of the IGC file. An appropriate PC program can check therefore if the assigned task was completed correctly.

When setting up a Competition-Route without a start cylinder, i.e. without a start time, the automatic switch over to the next waypoint is effected, as soon as the pilot is present inside the 1. cylinder radius. So it makes no sense to choose the “Take off” place as the 1st waypoint, because immediately after receiving satellites the instrument switches over to the next waypoint.

2.6.6.2 Competition-Route Set – Alter – Delete

Even so a called-up Competition Route is treated differently than a usual Route during flight and also for data transfer after the flight's completion, there is no difference when setting or changing it. The route can be set up with the help of the keypad of the instrument or can be transferred from the PC. This feature is particularly useful for Competitions when in a short time the flight tasks on the basis of turning points have to be distributed error free to many pilots. The waypoints of the Competition-Route can be altered, however the designation „COMPETITION Route“ can not be deleted. If the Competition-Route does not contain any waypoints, it cannot be selected. Each one of the other existing Routes can be copied to replace the Competition Route. (In *Main Setup Menu* ⇒ *Routes* ⇒ *selected Route* press the **McC** key). This same key is also used to assign to one waypoint the status of start cylinder.

COMPETITION-ROUTE	
=====	
Flytec	0.4S
Fiesch	0.4
Flims, Station	0.4
Cassons Grat	0.4
Stanserhrn-Arv	0.4
Engelberg	0.4
=====↓	
wp1/6 in Route	
Flytec	
Total Dist: 16	
Radius[m]: 2	
Start 14:15+05min	
Gates 02	EXIT

After pressing the **OK** key, the start mode (ENTER or EXIT), the cylinder radii and the start time are to be set. It is possible to use the same waypoint several times consecutively with different radii (e.g. the arrival cylinder and the landing place)

2.6.6.3 Distance to Waypoint cylinder

In order to ease the decision if having to peel off, the user field “Dist.Cyl” displays the distance to the radius of the actual waypoint cylinder. This is particularly helpful for start

cylinders, as one has not always memorised at which size the start cylinder was entered.

2.6.6.4 Dist to Goal (Total distance to the Goal of a Route)

In this field there is displayed during flight of a Route the sum of the legs lying in front of the pilot. The distance is calculated from the current position. Thus he knows at any moment, how much km are still in front of him until completion of the task

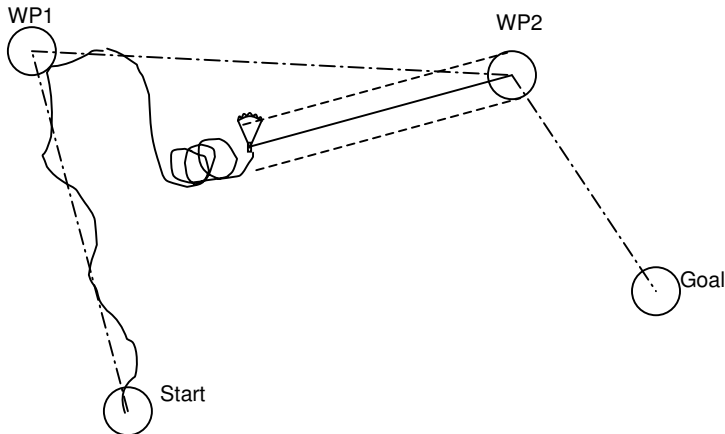

2.6.6.5 Distance to starting point

The instrument memorises the coordinates of the point, where the **start recognition** (flight acceptance) has begun. **This is a GND Speed of 10km/h for more than 60 seconds.** With user field "Dist.Start" the distance to this point can be illustrated. Usually this is the point from where one has started.

2.6.7 Diff. BGGoal

Furthermore it is possible to pre-calculate the expected arrival altitude above goal over several waypoints for display in the user defined field „Diff.BGGoal“. This computing incorporates wind strength and direction, which one has determined by flying a full circle.

Hereby it is assumed that one is flying from the actual position in direct flight to the next waypoint, and continues from there on the Route. The calculation is assuming that one is covering the leg with the speed of best glide. On this note it is simply an estimation, allowing the pilot to determine his strategy under consideration of local topography and of wind components. The display shows the pilot if he has sufficient height to fly over the last waypoint directly to the goal. See also chapter 2.7.4 (= L/D ratio) page 32.

2.6.8 Relocating Thermals

With weak or widely dispersed thermals this function helps to relocate any lost thermals. A small arrow pointing up in the compass rose shows the direction to the last thermal with at least a 1 m/s climb. If this arrow is positioned **at the top** of the display, then you are flying towards the thermal, however, if it is positioned in the **lower part** of the display, you are flying away from the thermal.

In case one wants to use this function, then the indicator "Dist Therm" should additionally be activated in the user defined fields. This value indicates the distance from the pilot to the last Thermal.

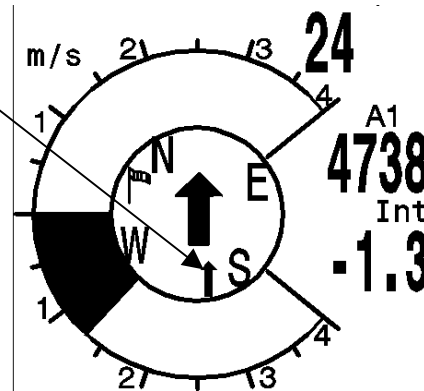

The threshold level to which the arrow should be pointed can be set under *Main Setup Menu* ⇒ *User Settings* ⇒ *Variometer* ⇒ *Thermal threshold* from 0.5 up to 3m/s. Therefore the arrow is not pointed directly to the centre of the thermal, but to its periphery, as one obviously should relocate the entry area.

2.6.9 XT Error, Crosstrack Error

This field indicates the shortest distance (perpendicular to the Track and related to a map view) to the active leg of a Route.

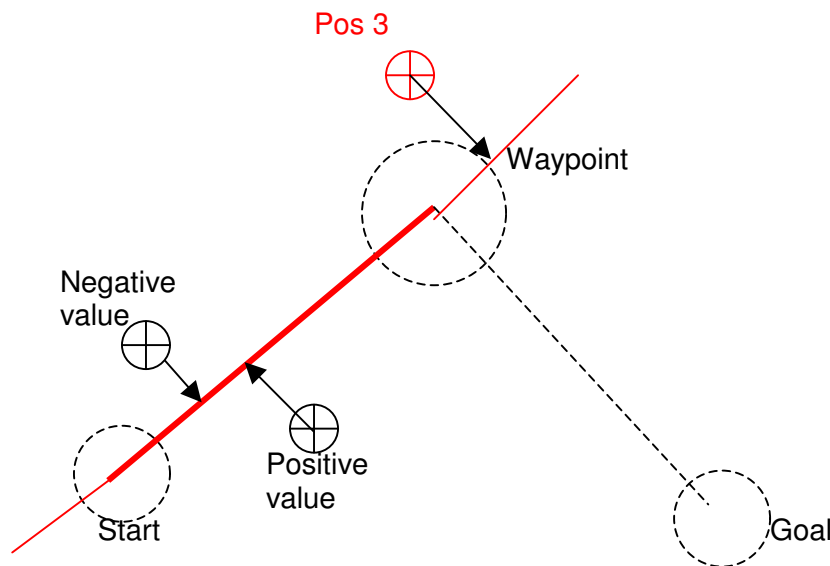

The accuracy of the indicated value depends on the length of the active leg. The largest Inaccuracy arises in the centre between start and the next waypoint, if one is very close to the track (the angles become very flat). With 50 km distance between start and waypoint, the inaccuracy in the centre can reach up to 400m. Positive values are displayed if one is on the right of the track, negative values on the left of the track. Even if one has cross flow over the next waypoint, the distance to the straight line is shown. (see position 3).

2.6.10 Air Space - CTR (Restricted areas)

On the Competino+ up to 150 CTR's can be entered. The CTR's may comprise straight lines and arc segments, or also be circles. These sectors appear in the Map Mode. Each CTR may be composed of max. 110 waypoints.

CTR's can be entered into the instrument either manually in *Main Setup Menu* ⇒ *Airspace*, or with less effort by assistance of a PC-program, e.g. Flychart, this program may be downloaded from our Internet Homepage at (www.Brauniger.ch).

- Without activation the user has 20 CTR's at his disposal. One can in Basic Settings -> Init CTR's call-up the CTR Innsbruck into the instrument and then alter it in Main Setup Menu -> restricted areas.
- With activation code there may be used up to 150 CTR's, depending on how complex they are. It is necessary to activate the SW Package 02 for this purpose.

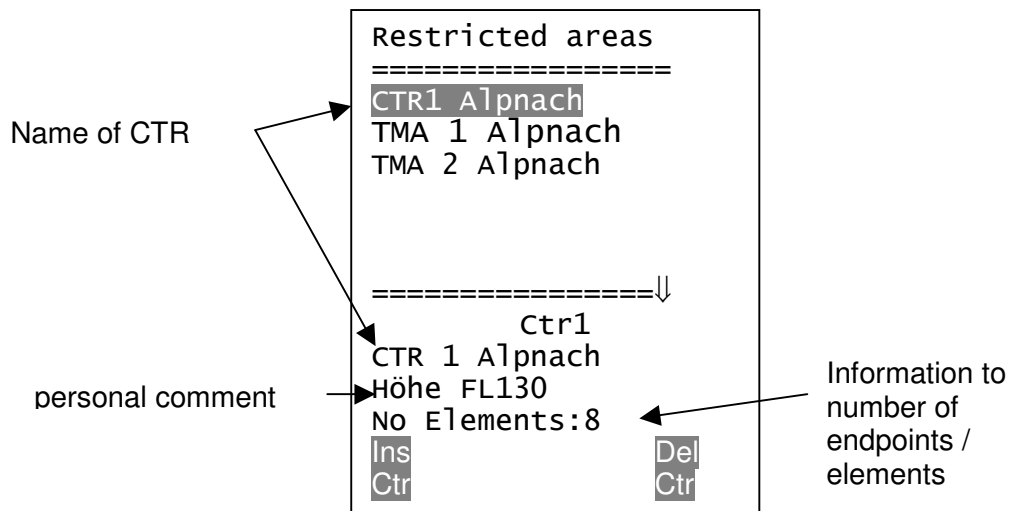

The CTR is defined by endpoints and arc segments or just by a circle. When entering these elements it must be taken care of that the endpoints are precisely created in their order of appearance (to the right or to the left) in which these lines should be displayed later. The Competino+ instrument draws automatically a line from the recent waypoint to the first one. It is therefore not required to repeat as last waypoint the first one.

As type the following elements can be selected:

- Point: endpoint
- Centre: centre of arc segment
- Startboarder: startpoint of arc segment
- Stopboarder: endpoint of arc segment
- Circle: centre of the circle plus Radius

example
counter-clockwise

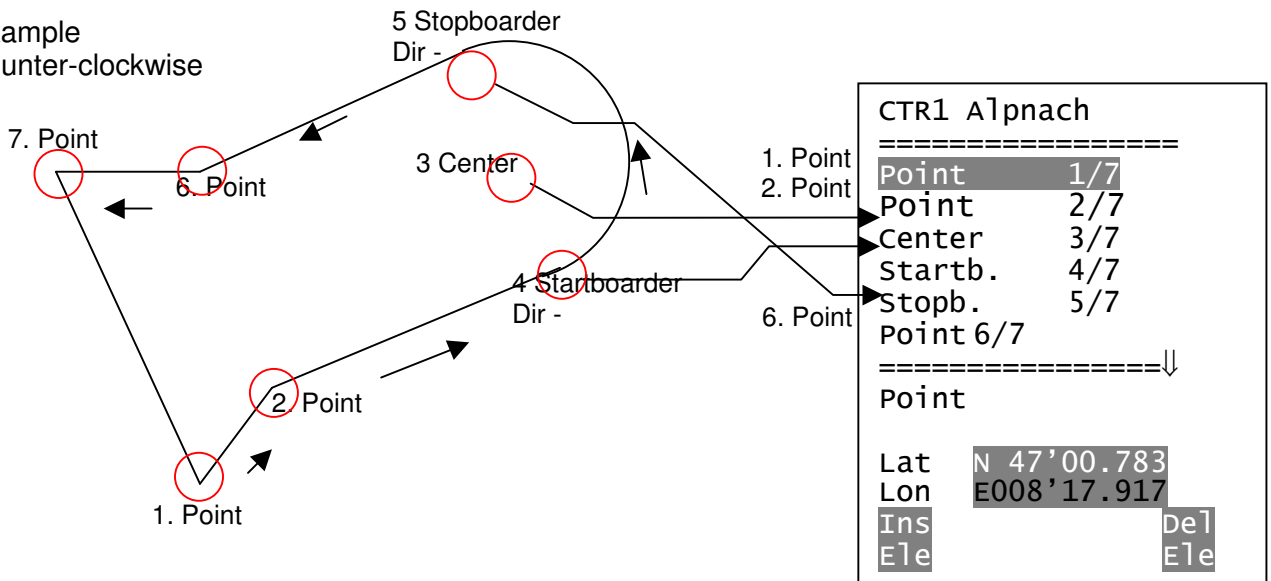

To enter **arc segments**, then the following sequence must be observed:

Long, Lat centre;
Long, Lat start point of arc segment;
Long, Lat endpoint of arc segment;
Rotational direction (+clockwise, - counter-clockwise)

For **circles** the centre and the Radius are sufficient

Long, Lat of centre;
Radius in km.

2.7 Flight optimisation

2.7.1 Groundspeed (Speed over ground)

The GPS-Receiver calculates its new position once every second. Speed over Ground is derived from the distance between these positions. From the difference between Airspeed and Speed over Ground it is possible to reach conclusions about the wind's influence.

2.7.2 Head- Cross or Tailwind; the Wind component

During a flight to goal or in calculating a final glide, it is not really the absolute value of wind, but the wind component, i.e. the difference between Ground speed and Air speed, that is decisive. In most cases the wind does not blow directly from the front or from behind, but somewhat from the side. If this wind component "Spd-Diff" (in the user defined fields) is positive, then the pilot will fly with a tail wind and the glide ratio over the ground will improve. If it is negative, it contains at least a part of head wind and the glide ratio over ground will decrease. The Competino+ takes this wind portion in any case into consideration for calculation of the final glide. The Windspeed can be displayed as user field.

If the windssock indicating the wind direction covers the wind symbols N E S W, then for reasons of clarity the corresponding letter positioned below shall disappear!

2.7.3 Wind direction and Wind speed

It is very important to know the wind in direction and strength, especially in case of an out landing. The Wind strength can be selected in the user defined fields. However, for this purpose it is necessary to fly one or two complete circles as steadily as possible. Whilst circling, the Competino+ determines the direction of least speed over ground and checks also synchronously if in opposite direction there might be the fastest speed over ground.

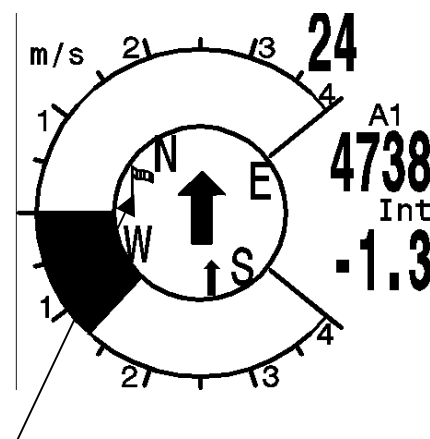

Therefrom it is possible to compute the values for wind direction and wind speed. Wind direction is shown in the compass rose at the position from where the wind is blowing by a small windssock symbol. During the landing approach this symbol should always be at the top.

2.7.4 Glide ratio (= L/D ratio)

By definition, the glide ratio is calculated by taking the horizontal distance travelled and dividing it by the height which was lost. If instead of the horizontal speed is taken the speed through the air, the error is 2% at glide ratio 5 and just only 0,5% at glide ratio 10. This small inaccuracy is insignificant and may be disregarded

Within the user defined display fields the glide ratio may also be selected.

Hereby the following facts are applicable:

Glide ratio through the air:

$$L/D_{Air} = TAS/Sink \quad \text{True Air Speed divided by Sink rate}$$

Glide ratio over Ground :

$$L/D_{Ground} = GS/Sink \quad \text{Speed over Ground divided by Sink rate}$$

Required Glide ratio over Ground from momentary position for reaching selected WP:

$$L/D_{Req} = \text{Distance to the WP} / \text{Height difference to WP}$$

Required Glide ratio over Ground from momentary position for reaching the goal.

example for explanation of glide ratio (L/D) values:

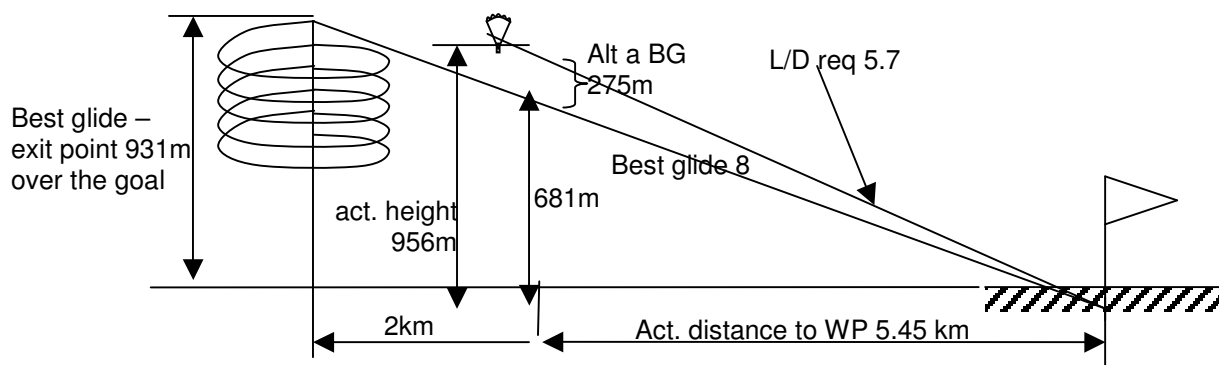

This field indicates the required glide ratio over ground to the goal crossing several waypoints. **This user field is only displayed if a Route is active.** This way it can be decided, whether one should be flying directly to goal while crossing several waypoints, or whether one must gain height in between within a Thermal. The calculation does not take into account if there is a waypoint in between with higher altitude than the direct line from current altitude position to the goal.

2.7.5 Safety altitude over the path of best Glide – Diff.BGWayp and Diff.BGGoal

In order to evaluate if one has sufficient safety altitude, these two user fields display the difference between current altitude and the altitude which is necessary to reach the goal with the speed of best glide. The best glide includes the momentary flight conditions. Upwash and downwash, as well as head- or tail wind are also taken into account. However, this calculation does not consider that on the path to the active waypoint other climb- or sink zones can be incorporated, or that the wind values accounted for in the computing can be

subject to modification. Furthermore the glide ratio for best glide as entered into the instrument settings must be correct.

If the Diff.BGWayp is positive, it represents a safety altitude which the pilot may lose accessorially for reaching the active WP even so while flying with the speed of best glide. If this altitude is negative, the pilot needs to circle up to at least the indicated altitude for reaching the goal.

Diff.BGGoal calculates this altitude over several waypoints of a Route to the goal, starting from the current position.

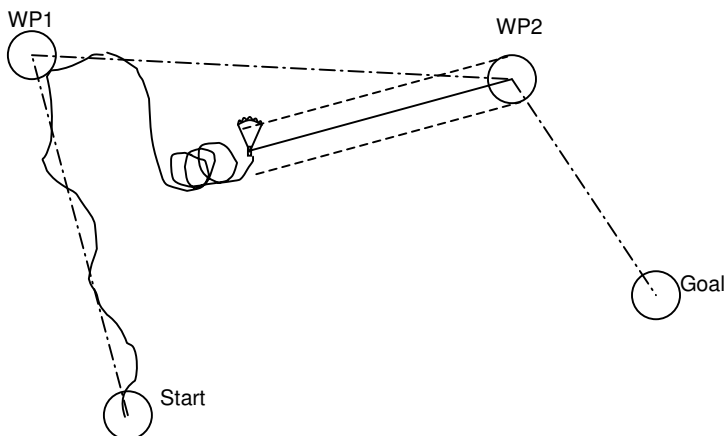

2.7.6 Display screen final approach

In order to realise all these data at a glance, the Brauniger Competino+ provides a specific display screen which shows the pilot in an intuitive mode, if he can reach his goal and in which way he can reach it optimally.

After repeated pressing of the  key the display screen for final approach appears as in the illustration on the right, for graphic presentation of the calculation for final approach. Cross hairs show the path to goal, a glider symbol in relation to it, and the pilot's position.

The horizontal scale of the cross hairs shows the deviation between current track and goal (e.g. caused by shearing winds). Each graduation line corresponds to 10°. In the illustration the pilot is drifting by 22° too far to the right.

The vertical scale shows the glide ratio. In the intersection of cross hairs is positioned the best glide ratio of the wing as entered into the Basic Settings. When wind is encountered, this glide ratio shall be rectified by the corresponding wind component.

Each Graduation line corresponds to 0,5 glide ratio.

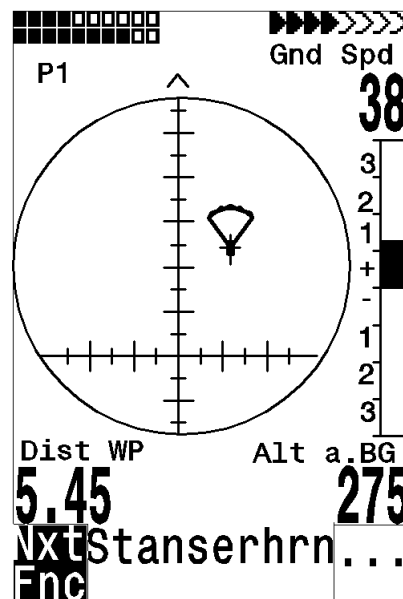

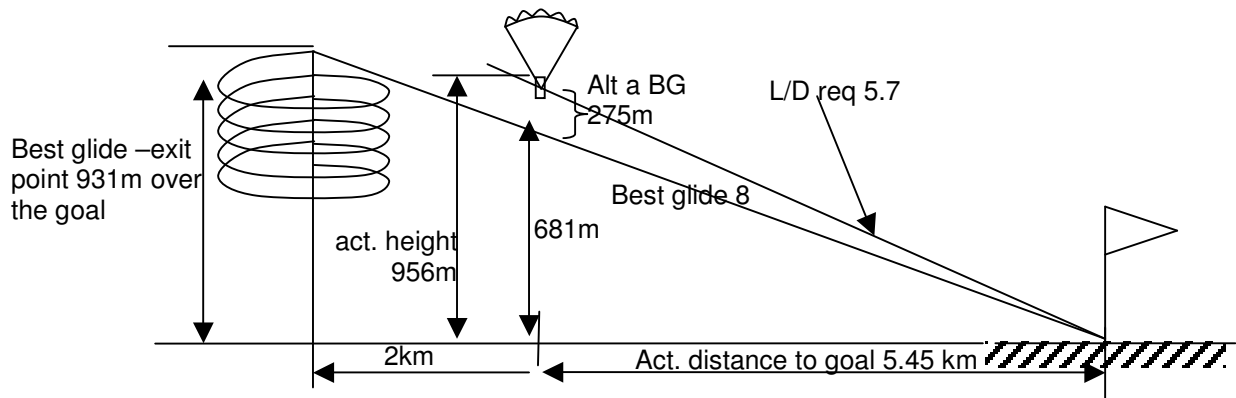

For the example given above the pilot has entered the best glide ratio 8. If he would be precisely on the path of best glide, the wing symbol would be exactly on the horizontal line, and „Alt a.BG“ should be 0. Because his distance to goal is still 5,45 km, his altitude should be in this case by $5450 : 8 = 681$ meters higher than goal. However, „Alt a.BG“ indicates 275 m, therefore he is by $681 + 275$ m higher than goal. The required L/D is indeed $5450 : 956 = 5.7$. This is precisely the value presented by the paraglider symbol.

The strategy during the final approach is to hold the symbol in the cross-point. In order to have some margin, experienced pilots will rather hold the symbol somewhat above the cross-point of best glide.

During thermalling, the symbol remains on the vertical axis. As long as the deviation is more than approx. 20 L/D, the symbol appears in grey in the centre. Below of approx. L/D 20 the symbol disappears. Upon approx. L/D 6 it reappears again on the screen bottom-up. When it goes upside over the upper margin, it will again appear in grey.

Also during thermalling there is a small arrow \wedge as exit assistance in the upper part, if Track and Bearing correspond to each other within $\pm 10^\circ$. When sinking the arrows $\langle \wedge \rangle$ show a recommendation in which direction one should head for. If the symbol leaves the range of approx. plus minus 60° , it shall be presented in grey. In this case one should shift back to the Vario screen using the  key, in order to see the compass rose with its direction pointers.

2.8 Battery - Management

Two Bargraph scales show the charge state of the batteries. The Competino+ is provided with 2 battery banks with 2 batteries each. Bank 1 must always be loaded. Bank 2 may be kept unloaded. However, it is highly recommended to also equip Bank 2. As soon as Bank 1 batteries are discharged, the instrument automatically switches to Bank 2. We recommend to place the partly discharged batteries of Bank 2 after a long flight into Bank 1 and to place new batteries into Bank 2. In doing this it is ensured that you may use up the batteries completely without taking the risk that during a flight all the batteries are discharged.

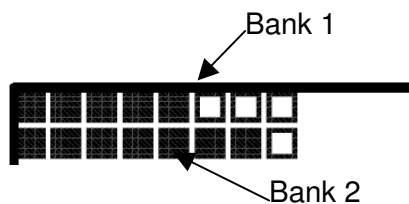

The following batteries are appropriate for use:

- 2 pieces each per Bank Alkaline High Power batteries 1.5V size AA.
Estimated operation time - 2 times 20h = 40h in total
- 2 pieces each per Bank NiMH accumulators 2100mAh or more, 1.2V size AA.
Estimated operation time - 2 times 15h = 30h in total.

The correct battery type needs to be set in *Main Setup Menu* ⇒ *Instr.Settings* ⇒ *Batterytype*.

If a wrong setting has been entered, it may induce to the result that the instrument prematurely switches off completely, when changing from Bank 1 to Bank 2.

We recommend not to use NiCd accumulators. These batteries have significantly reduced capacity and they are less environment-friendly. Also the switching threshold data are not laid-out for NiCd Accumulators.

The estimated operation time mentioned above is based on normal temperatures (20-25 °C). At low temperature the batteries and accumulators have a considerably shorter service life.

3 The Setting Menus

Prolonged pressing of the **OK** key gives access to the setting mode. With the arrow keys ▼ and ▲ one of the menu items is selected and pressing the **OK** key gives access to the relevant subdirectory.

3.1 User Settings

A series of settings allow the instrument to be programmed in accordance to the user's preferences. Every pilot may realise his very own ideas here. All the basic settings can be set comfortably on the PC by use of the PC-Software „Flychart“ and be transferred later to the instrument via the PC interface. Manufacturer's approved basic settings are called-up with *Main Setup Menu* ⇒ *Memory* ⇒ *Memory format*, and they are saved again in the settings. Please note to use this setting in case of emergency only, because hereby all waypoints and Routes shall be erased. In most cases the possible setting range and its previously valid value is indicated individually for each of the settings. If this value should be modified, pressing the **OK** key gives access to change mode, the value to be modified will blink and can now be changed by use of the ▼ and ▲ arrow keys. Pressing the **OK** key confirms the new value, pressing the **ESC** key recalls the previous setting.

Term	Denotation	more info	Factory setting
Variometer			
Ground filter	Diagnose of time constant f. Vario and Speed	14	12 (≈ 1,2 sec)
Digital Vario Integrator	Shift Integr.- Netto-Vario; Integr.-time constant	14	Integr. 1 30 sec 1 sec
Thermal threshold	Threshold for the last climb	29	
Variometer Acoustics			
Acoustics settings	Climb tone frequency, modulation; Sink tone frequency. Acoustics dampening; Pitch	15	1200 Hz; Mod = 5, 700 Hz, 8, Pi = 3
Climb acoustics activation threshold	Fine tuning of climb tone threshold, max 20 cm	15	2 cm/sec
Sink tone activation threshold*	Activation point of Sink tone	15	0,8 m/s (ft/m)
Speed			
Sensor setting Wind vane	Correction Wind vane 70 ... 150 %	17	100 %
Stall Speed	Activation of Stall alarm and altitude limit	15	0 km/h (mph)
Flight Memory			
Recording Auto/Man	Automatic or manual Flight recording	38	Aut.
Recording interval	Time interval per recording point - 2 to 30 seconds	38	10 Sec
Polar curves	Glide ratio at speed of best glide	28	L/D 8 to 40km/h
Pilot name	Entry of pilot's name; max 25 char.	10	not set
Glider type	Name of aircraft for OLC	10	not set
Glider ID	Ident.No. of aircraft for OLC	10	not set

3.2 Memory Management

Delete all Flights	Deleting the entire flight memory. This command reformats the flight memory, while all the other settings are not lost.	38	No
Delete all WP's & Routes	Deleting all WP's and Routes	21	No
Formatting Memory	Reset of Basic values to factory settings	38	No
Delete all Air Space CTR data	Reorganisation of the Memory zone for the Restricted Areas (CTR's)	29	No

Caution: When deleting WPs, Routes or flights, the deletion process takes a couple of seconds, please wait during this time span.

3.3 Instrument Settings

Term	Denotation	more info	Factory setting
Display contrast	Range 0 .. 100 %		70 %
Language	Selection is possible from 5 different languages		English
Battery type	Battery type. Selection possible between Alkaline or NiMH accumulators		Alkaline
Time zone	Difference to UTC; 0.5h time zones can also be set		-2
Units	Meter or feet; Km/h or mph or knots. Temp. in °C or °F		m ; km/h ; °C
Coordinate format	dd'mm.mmm or dd.ddddd or dd'mm"ss UTM or Swiss-Grid		dd'mm.mmm
Pressure sensor Corr	This setting allows correction of a possible deterioration of the pressure sensor. For check up the QNH-value is used. If you know the QNH-value of a certain location (e.g. airfield altitude), the altitude needs to be consistent with the effective altitude. 1hPa corresponds at 500m to approx. 8m.		0 hPa
Bluetooth	Only active when SW Package Bluetooth is activated. Here is made the Pairing of the Bluetooth interface for the SMS function.		
SMS	Only active, when Bluetooth and SMS SW Package is activated. Here is entered the target telephone number and the Mode.		
Opt. Software	Here are activated additional SW functions (Packages). For this purpose the relevant manufacturer's Code is required.		
Factory Settings	Disabled Zone		

3.4 Specific Instrument factory settings

This default value, which is not accessible to the pilot, contains all basic settings of the instrument. In particular, both the sensor specific parameters and all calibration data are located here. These data are not lost, even when the power supply is missing.

4 Flight Memory and data analysis

The flights are recorded inside a Flash-Memory (see below). Each trackpoint contains time of day, position, GPS-altitude, barometric altitude as well as speed through the air. Due to this feature it is possible later on to reproduce the barograph and individually the graph for Vario, Speed, and the track (course) of the flight over a map presentation. These data are processed for flight analysis by various analysis programs. With Flychart 4.52 it is for example possible to retrace the flight on the PC-monitor in three-dimensional mode over the corresponding territory. (Google Earth).

The Brauniger Competino+ provides in total 3 memory zones.

Content	Type	Access with	Delete
Program Memory	Flash	Flasher tool at switched-off instrument	The Flasher tool overwrites the memory each time
Flight Memory	Flash	<i>Main Setup Menu</i> ⇒ <i>Flightmemory</i> readout of flights over the USB interface	<i>Main Setup Menu</i> ⇒ <i>Memory</i> ⇒ <i>Delete flights</i>
Waypoints, Routes and Air Space	EEPROM	<i>Main Setup Menu</i> ⇒ <i>Waypoints</i> or ⇒ <i>Routes</i> or ⇒ <i>Airspace</i>	<i>Main Setup Menu</i> ⇒ <i>Memory</i> ⇒ <i>Delete Wp&Rt</i> or ⇒ <i>Delete Airspace</i>
User and Instrument Settings	EEPROM	<i>Main Setup Menu</i> ⇒ <i>User Settings</i> or ⇒ <i>Instr.Settings</i>	<i>Main Setup Menu</i> ⇒ <i>Memory</i> ⇒ <i>Format. memory</i>
Serial number, Adjustment data	EEPROM	<i>Main Setup Menu</i> ⇒ <i>Instr. Settings</i> ⇒ <i>Factory settings</i> Password protected	Not possible

4.1 Flight-Memory and Flight-Analysis

The recording mode does not need to be specifically activated, as each flight is automatically saved.

The flight memory used in the Competino+ not only records flight altitude and flight speed TAS, but it also logs the position of the pilot and the GPS altitude in the WGS84 co-ordinate system.

In *Main Setup Menu* ⇒ *User Settings* ⇒ *Flightmemory* ⇒ *Recording Interval* the recording interval can be set. The set value determines the time interval counted in seconds, after which a new data record is entered into the memory of the Competino+. The minimum value is 2 seconds, which is in accordance to a recording time of approx. 9 hours. At maximum value of 60s, the total recording time is approx. 291 hours.

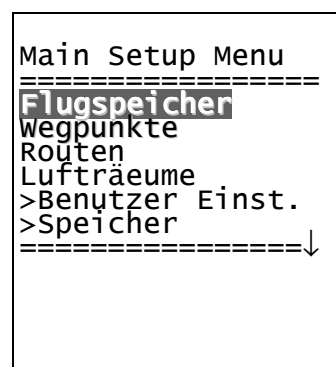

For tests or acrobatic flights a sampling rate of 2 seconds is recommended. However, the recommendation as standard setting is a *recording interval* between 5 and 10 s. With it also narrow curves are well recognisable, and the number of data points for the external computing of OLC points remains manageable. Factory setting here is 10 seconds. For the beginning of a flight the following arrangement applies: **the start is recognised as soon as the ground speed reaches at least 10 km/h for more than 60 seconds, or if altitude difference within 60s is more than 30m.**

In each case however, the previous flight history with up to 30 recording points is filed in the Competino+ memory. With it, and at 10 sec. recording interval, even the last 3 minutes before the start of the filed flight can be noted.

Flightmemory	
=====	=====
24.09.04	1:09:04
23.09.04	1:18:25
18.09.04	0:11:14
15.09.04	2:38:23
30.08.04	0:09:34
24.08.04	1:23:35
=====	=====



An end of flight is recognised under automatic recording if there is no speed for 60 seconds (less than 10 km/h speed or airspeed) and also if no change in altitude occurs. Then the standard display screen is automatically switched to flight analysis. From this moment on the “digital signature” of this flight is calculated and a notice is displayed in the info field. Please wait until this calculation is completed. With short pressing on the **ESC** key one returns to normal mode.

It is also possible to shift the instrument to **manual recording**. For this purpose it is necessary to select under *Main Setup Menu* ⇒ *User Settings* ⇒ *Flightmemory* ⇒ *Rec. Auto/Man* the value “No”.

This setting enables the recording to start approx. 10 seconds after switch-on and is only stopped after the ESC key has been pressed for 3 seconds.

The start of recording is visible by the running “Flight time” counter. Please take into account that altitude A1 may not be changed during recording process.

Caution: Make sure before the start that the GPS-Receiver indicates to receive at least 4 Satellites in order to achieve valid recordings.

Comment 1: in the Flight analysis are displayed max. values which appeared during the flight. Due to the fact that the display screen is updated every second, the 1-second values are saved for the flight analysis. If one undertakes a download of such a flight afterwards on the PC using a program such as Flychart, SeeYou, CompeGPS, MaxPunkte etc., these programs are only appropriate to analyse the flight records in IGC format. In the IGC file are saved the time of day (UTC), position, barometric altitude, GPS-altitude and True Air Speed of the wind vane or pitot pressure sensor. The programs calculate the Vario-meter values out of the altitude data. If for instance, one has set a recording interval of 10s, and has made a height difference of 5m during these 10 seconds, the Vario value of 0.5 m/s shall be calculated. However, during this time a 1-second Vario value of 2m/s may have been performed. Only this value shall be indicated on the Flight-Analysis page and is not subject to electronic readout.

Comment 2: Although the instrument is capable to store up to 100 flights, we recommend to save the flights in regular intervals on a PC and to reformat the flight memory afterwards by entering the command *Main Setup Menu* ⇒ *Memory* ⇒ *Delete Flights*. This procedure ensures the safety of data storage of your precious flights and that the instrument may perform new recordings again with a „refreshed“ flight memory.

4.1.1 Logbook and Flight Analysis page

After leaving the Flight-Analysis the flight is saved in the flight memory. Data and Track of the flight can be viewed on the Flight-Analysis page. Under *Main Setup Menu* ⇒ *Flightmemory* appears the list of saved flights in chronological order. The recent flights rank first. The duration of the flight is also displayed. With the keys ▼ or ▲ one scrolls through the list, using the **OK** key, the required flight is called-up and is displayed along with its basic values on the Flight-Analysis page. By pressing the key **F2** Del. Flight it is possible to delete flights individually from the list. If the entire flight memory should be deleted, item *Main Setup Menu* ⇒ *Memory* ⇒ *Delete flights* is to be selected.

FLIGHT-ANALYSIS	
Date:	24.09.04
Start:	06:19:06
Stop:	06:27:56
Fltime:	0:09:04
Scanrate:	10s
Max A1:	1153m
Max A2:	4273m
Max A3:	418m
M.Vario:	8.9m/s
M.Vario:	-6.6m/s
M.Speed:	73 kh
Shw Map	Rec Sig

4.1.2 Graphic Display of flights in Map format

The flight route of saved flights can also be shown on the Display screen for appraisal. In Flight-Analysis the key F1 is used for the function *Show Map*. After pressing this key the screen-optimised illustration of the flight route is shown (North is at the top!) In addition, stored waypoints are presented with a cross and the name, as well as the map scale as short line with indication of km.

The graph can now be changed as follows:

F2: Zoom in: the map scale is gradually increased to approx. 0,4 km. Thus individual circles during a climbing period are clearly recognisable. (dependent on the setting of recording interval).

F1: Zoom out: the map scale is gradually decreased, until the screen optimised graph is achieved.

The maximum is 47.4km

Arrow keys Pan: by use of these keys the illustrated area can be shifted up, down, left or right.

(Function not enabled during an actual flight).

OK: from each graph back to the screen optimised graph.

ESC: return to the Main Setup Menu

All the other keys cause the Track in the current selection to be redrawn.

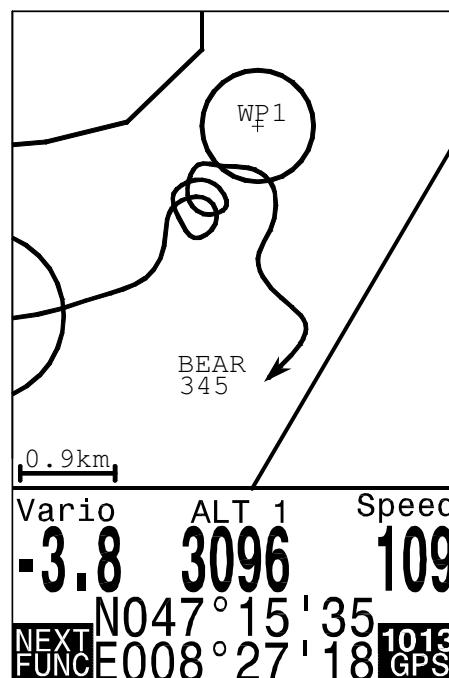

Remark: as the illustration will take a few seconds to appear according to the data volume, the message *Wait* and *Ready* appears on the status line as user information.

If a zoom or pan key is activated during the screen layout, the momentary process will be discontinued and will resume with the new values. Hence one can obtain the desired graph rapidly.

Remark: During the flight it is also possible to switch to a real time track and map graph by briefly pressing the **ESC** key. Vario, altitude and speed appear digitally under the map. For a Competition-Route also the cylinders around the WP's are indicated.

During the flight the current end of track (= the momentary position of the pilot) is illustrated by an arrow which is pointing in flight direction. The "Zoom out" zone has been extended (in 4 steps) so that in most cases a large part of the Route is displayed. The waypoints of the Route are linked by fine lines for better clarity.

4.2 Data transfer

In the memory of the Competino+ are saved all data entered by the pilot, such as waypoints, Routes, pilot's name etc., as well as the automatically by the instrument recorded tracklog-points of the flights being performed. Each one of these points contains the time of day, position, GPS-altitude, barometric altitude, as well as the flight speed. In this way it is possible to graph the Barogram, Variogram, Speedgram and the track (course) of the flight over a map presentation for later analysis. With Flychart 4.52 it is even possible to retrace the flight on the PC-monitor in three-dimensional mode over the corresponding territory. For this purpose the software program Google Earth needs to be installed.

4.3 Data exchange via PC

The basic equipment of the Competino+ includes a data cable for a USB PC interface USB Mini B. Due to this feature data transfer can be carried out in both directions. The data transmission is effected via serial interface COMX with: 57.600 baud; 8 databit; 1 stopbit; no parity, Xon/Xoff.

Using the USB interface the Competino+ can also be operated for **data readout and entry**:

- entire instrument configuration (Basic Settings, User def. fields)
- list of waypoints
- list of Routes

Only readout of flights saved in the flight memory is possible.

Important: for transfer of a.m. data the Competino+ must first be switched-on and the relevant program for data transfer has been called-up, before the connection cable to the PC is plugged to the Competino+.

Important: at first the USB driver as provided from Prolific has to be CD installed. Upon installation of Flychart the USB driver installation is effected automatically.

To perform data transfer the instrument needs to be switched to the *Main Setup Menu* by prolonged pressing on the **OK** key.

Please observe the instructions of the software being used for transfer of stored flight data. (For most software programs it is required to shift to the Flightmemory resp. to the Flight-Analysis mode).

There are various software programs available for creation of IGC-files, partly even for OLC-files. For more detailed information please check homepage <http://www.onlinecontest.de/holc/>

We recommend the use of Flychart which can be downloaded from the www.Brauniger.ch website.

With Flychart all instrument settings can be effected comfortably on the PC.

Trackview (Freeware) Daniel Zuppinger (for OLC and CCC) www.softtoys.com/

Maxpunkte (Freeware) Program by D.Münchmeyer for Online-Contest of DHV www.dm-sh.de

Compe-GPS For competition and private pilots, 3-D presentation www.compegps.com

Seeyou Flight planning- and Analysis software, www.seeyou.ws/

GPSDump Stein Sorensen . A simple program to receive IGC Files <http://www.multinett.no/~stein.sorensen/>

4.3.1 Flightinstrument Options

All settings can be set or changed comfortably with Flychart 4.52

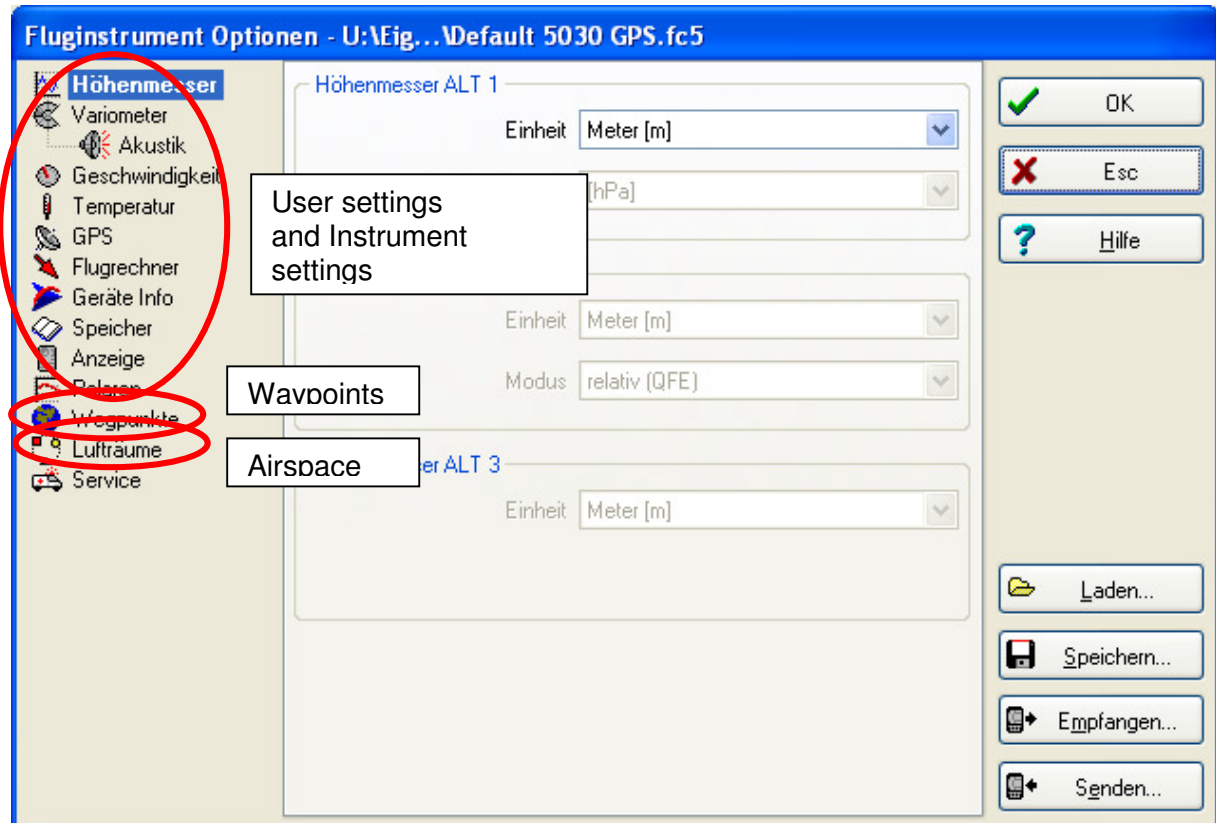

4.3.2 Waypoints and Routes

Within the same Flychart Menu the Waypoints and Routes may be transferred to the instrument. Flychart is also appropriate to import waypoint files from SeeYou or CompeGPS or Garmin for transfer to the instrument.

4.3.3 Airspace (CTR)

The same principle applies on Airspace. For this purpose please activate button „Airspace“.

4.4 Transferring new software to the Competino+

As is the case with many other present-day instruments, there is also the possibility to up-date the software version (Firmware). Hereby future requirements presented by pilots or new Competition regulations may be rapidly implemented. The manufacturer Brauniger shall post from time to time program up-dates of the Competino+ firmware on its Internet homepage, which can be downloaded by the user free of charge for storage and subsequent transfer to the Competino+.

In order to be able to write into the Competino+ flash memory with a PC, the program “Flasher.exe” is required, which is available in zipped format file under the name of “Flasher.zip”. In addition, also the intrinsic firmware to be uploaded has to be obtained from the homepage. Its name is e.g. “6020v325.moc” (approx. 500 KB) which is equivalent to version 3.25.

We recommend to save all the related files in one single subdirectory (e.g. C:\Programs\Brauniger Flasher\).

After decompressing the ZIP file a number of files are created. Double clicking on the file "Flasher.exe" starts the program.

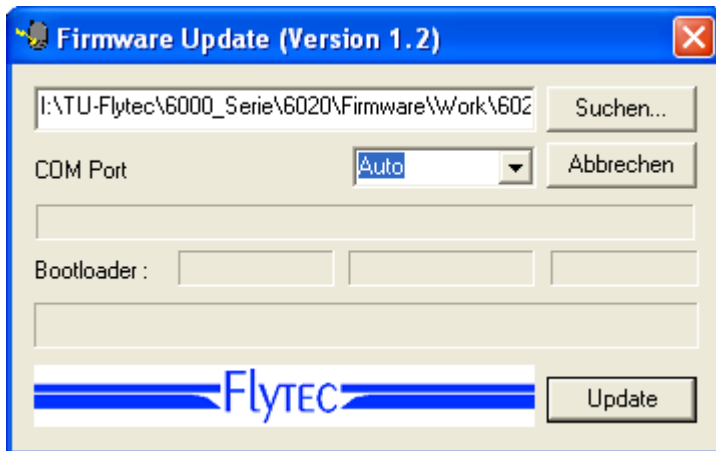

One can set the interface, or in case it is not known, having it done by automatic search. With "File" you select the program to be transferred with the extension ".moc" or you can pull it from the Explorer into the field by drag & drop. Boot the data transfer. The Bootloader version of the instrument will appear and the transfer rate. The numbers appearing in the field on the right side are the instrument's response.

Important: By contrast to the flight data transfer make sure that the Competino+ **is not** switched-on when the connection cable to the PC is plugged.

Caution: Never leave the PC cable hooked to the instrument for a longer period when it is turned off. Indeed this is energy consuming and the batteries could be discharged unnoticed.

Lead: In Windows the characteristic noise for USB devices should be audible when the unit is plugged.

5 Miscellaneous

5.1 Optional Software (additional Software)

With the help of an activation code available from Brauniger it will be possible to enable additional special functions. For example by use of a 5-digit Code the diagram of Restricted Areas (CTR's) can be activated.

Procedure for Code entry:

- Select in Menu Optional SW Packages the corresponding package
- Press OK. Then a Code -29XXX will appear
- By use of the arrow-down key the Code jumps to 30000 and then counts downwards.
- Set the Code by use of the arrow-down key and press OK
- The instrument signals: Package released!

If a wrong Code has been entered, the instrument remains blocked for min. 5 minutes!

6 Simulation

After choosing the Simulation mode in the Setup Menu and pressing the **OK** key, you have access to this highly interesting function. With the *arrow keys and OK* you shift the Simulation checkbox to “Yes” and confirm again with **OK**. Now the simulation starts and the last known GPS position is applied.

With the ► and ◀ arrow keys you can adjust the speed through the air and ground speed; the ▲ and ▼ arrow keys change the sink or the climb. If the stall alarm sounds, please increase the airspeed by a few km/h.

The softkey F1 is used to change to various functions:

Next Func.	Var ▲▼ Spd ►◀XX	altering Climb/Sink Air + Ground-Speed
Next Func.	Wind ▲▼ Trk ►◀	altering an assumed windstrength during climb and altering of the Track (Flightdirection) during sink
Next Func.	Mod A1 ▲▼	altering altitude Alt1
Next Func.	Mod A2 ▲▼	altering altitude Alt2
Next Func.	S.Thr –▲▼	altering the starting point of sink acoustics
Next Func.	Change page ►	

Likewise, the **Goto** function can be called up to select a waypoint. The distance to this waypoint appears. If the direction arrow in the middle of the compass points upwards, the pilot is moving towards his goal and the distance becomes shorter while at the same time also the altitude naturally decreases. If you now initiate a climb with the ▲ key, the Competino+ simulates circling up in a thermal; the compass rose turns and the distance to goal continuously changes between somewhat closer and somewhat farther away.

Under simulation mode one can also test the different climb tone acoustic adjustments, such as frequency, pitch and modulation during a virtual climbing.

Please shift back to dive. After pressing the  key one can change by use of the ▲ and ▼ keys the Speed over Ground, i.e. simulate the wind influence. By using the ◀ and ► keys it is also possible to change the flight direction, e.g. in order to fly directly to a WP.

One can also retrace perfectly in simulation a called-up Route. If you select the Route as FAI-Route, you will hear the characteristic tone upon approaching the waypoint at about 400 meters, which signals that you are inside the cylinder, and you can see the automatic switchover to the next WP too. (Caution: for automatic switch-over the count down timer must show positive values).

By pressing the ESC key one can switch to map display and observe the approach to the WP cylinder. If one has selected the function Wind Track with the F1 key, it is real fine to simulate the influence of head or tail wind during approach to the goal. It is indeed informative to see the influence of head wind on the display of Alt a BG.

During simulation mode the GPS-Receiver is switched-off and instead of its bar graph the word “*Simulation*” appears.

A simulated flight is well stored into the memory of the Competino+, but its “Digital Signature” is not valid.

7 Disclaimer of Warranty:

In rare cases it might happen that the instrument does not provide any data at all or incorrect data. The Company Brauniger GmbH shall reject any claim on damage resulting from malfunction of your instrument. It is solely the pilot who is fully responsible for the safe performance of his flights.

7.1 Landing in Water

In case you are forced to land in water with your Competino+ and it may have penetrated the instrument, there is still a chance to save the instrument or at least some of its parts.

Once water has intruded the GPS module it is then irrevocably lost. Take out all batteries as fast as possible, thereby the circuit is disconnected from power supply. Then afterwards the casing can be opened.

In presence of aggressive liquids, such as salt water, place the circuit board and all parts affected by the salt water into warmed freshwater for a minimum of about ½ hour. Thereafter dry the instrument carefully with warm air (hair dryer). It is also recommended to remove the flat cable of the keypad.

Please return imperatively the dried instrument to Brauniger Company for final check over.

Any claim under Warranty is void after a Water landing.

8 Technical Data

Dimensions:	178 x 95 x 40 mm	
Weight:	425 Gram (without harness)	
Power supply:	2 or 4 pieces Alkaline batteries AA, 1.5V	
Battery operation time:	> 20 hrs. per Bank, i.e >40h	
Altimeter:	max. 8000 m	Scale 1m
Variometer:	analogue ± 8 m/s	Scale 0,2 m/s
digital	± 100 m/s	resolution 0,1 m/s
Speed wind vane	digital 0 up to 120 km/h	
Waypoints:	200 WP	
Routes:	20 Routes with max. 30 WP each	
Max. storage time:	48 hrs. Flight time at 10 s recording interval max. 291 hrs. at 60 s recording interval	
Restricted Areas	20 CTR's free of charge, 150 CTR's as charged service	
Number of Tracklog points:	21 000	
Number of recorded flights:	100	

Data memory and transfer according to the IGC format

Screen resolution	38'400 Pixel / 240 x 160 Pixel (= 1/8 VGA)
Operating temperature	-15 C° ... 45 °C

Harness items for hang gliders and para gliders are available.

The Technical data may be altered without prior notification at anytime. Software upgrades can be made via Internet by downloading the latest firmware version from our homepage onto the user PC.

9 Appendix

9.1 Altimeter

An altimeter is really a barograph because it doesn't directly measure altitude, but air pressure. Altitude is calculated from air pressure data. The pressure at sea level is used as zero point altitude for the calculation of absolute altitude (according to the international altitude formula).

Why does pressure change with altitude? Pressure at any given point on the earth is created by the weight of air in the atmosphere above it. Therefore, pressure reduces with height – there is less air above you. A change in pressure of 1 mbar at 500 metres local altitude above sea level is a height difference of about 8m.

However, in practice, it is not as simple as that because more factors have influence on air pressure. Therefore, air pressure is also depending on temperature and of course, on weather conditions. On a stable day, temperature induced air pressure variations of 1mb can occur, which means a height difference of ± 10 metres. Depending on the weather, air pressure at sea level (QNH) may vary from 950 mb to 1050 mb. In order to eliminate the influence of the weather, the altimeter has to be calibrated again at certain intervals. This means the altimeter has to be set to a known height and it needs to display this height.

During rapid weather changes (e.g. passage of a cold front), the air pressure can change by up to 5 mbar during one day. This means a height difference of 40 m!

Another alternative to calibrate an altimeter is setting it to the actual QNH.

What is QNH? General air traffic needs a common zero point. This means that at a certain altitude all aircraft show the same altitude on the altimeter. This common reference basis is the QNH. The QNH is the actual air pressure in hPa (1 hPa=1mbar) calculated back to sea level. It is calculated several times a day and can be taken from the weather forecast for aviation or it may be requested by radio from airfields.

9.2 Speed

9.2.1 True or Indicated Airspeed - TAS or IAS

In general aviation it is customary to measure the airspeed by use of a pitot tube as a dynamic pressure speed (=IAS) and also to display it as such. The advantage of this method is the fact that at any altitude level the maximum admissible speed or the stall is marked (flight safety) at the same position on the scale. Furthermore it is the same for the speed of best glide for any altitude which is on a fixed position on the scale (flight performance).

It is however the disadvantage of this system that all geographic calculations, such as for distance, required flight path angle, and all final approach computing, necessitate the true air speed to perform the calculation.

Another disadvantage is the fact that the indicated speed is correct **only at one** certain altitude (usually at sea level). The higher one climbs, the glider will fly increasingly faster due to the air getting thinner, without the display screen following this fact. At approx. 6,500 m the air weighs only half of that at sea level, therefore the air speed will increase by 1.41 times (as a radix of 2).

The physics could be pictured as follows:

In order to create a certain lift a certain number of air particles need to hit the airfoil. Because of the fact that at 6,500 m altitude there are now only half as many particles present per meter, the wing surface has to fly faster, but not twice as fast, because each particle has a higher striking energy and is then only 41% faster.

However, for the calculation of wind, arrival altitude or arrival time at goal, the true air speed values are always required. The wind wheel sensor shows the true air speed (=TAS), because it runs practically without friction.

The Brauniger Competino+ indicates generally the true air speed - TAS.

9.2.2 Stall alarm

If a pilot slows down his glider gradually, he will cause a stall when falling below a certain speed, which will have different consequences, depending on the type of aircraft.

If the air current is suddenly cut-off from the entire surface, then a completely unforeseeable crash would be pre-assigned. For this reason, our wing manufacturers are building a so-called cross-setting into the support parts of the wings; this means that during flight the wing tips will always have a smaller stalling angle than the middle part of the glider. If the air flow stalls in the middle part of the surface when falling below a minimum speed, then lift still remains on the wing tips. The aircraft is now in the so-called descending or stall. Due to the fact that the wing tips are positioned behind the aircraft's centre of gravity, the aircraft will independently drop nose downwards and try to increase the air current by gaining speed.

It is certainly to misadvise to remain a longer time span in this excessive flight situation, as the wing will react extremely sensitive to even minor air turbulences. A stall can be dangerous, especially during the landing approach. The consequence could result in a stall over one surface or a non intended 180-degree curve. The stall alarm is a loud, concise acoustic signal that requests the pilot to fly faster. It assists first and foremost hang gliders, however para gliders to a lesser extent. Anyone who has ever watched a hang glider come in during an approach can observe the following situation:

always when a good headwind prevails, many pilots will pull out their steering bar too early; the glider then climbs a few more meters to end up in a favourable case afterwards with its keel stuck in the ground. With no wind or with a light tail wind most pilots wait too long to pull out the bar. In this case, and with any luck the result will only be a belly landing; but also a ground-loop with broken base side tubes may be the result, or the glider's nose absorbs the impact energy when touching ground and the pilot will swing pendulum wise, hitting his helmet on the front keel tube.

There are different stall speeds to apply for each glider and varying weight of the pilots. Several tests are necessary to determine for the own arrangement the setting of correct stall alarm limit in *Main Setup Menu* ⇒ *User Settings* ⇒ *Speed* ⇒ *Stallspeed*. Furthermore it is worth to note that close to the ground, and because of the air cushion under the wings, the stall occurs at approx. 2 km/h lower speed than in the high air.

However, stall speed also depends on the specific weight of the air, meaning: the flight altitude. On the Competino+ the stall alarm level is automatically raised with increasing flight altitude, corresponding precisely to Indicated Airspeed. It is unimportant if the pilot has selected True- or Indicated Airspeed for the speed display screen.

The border limit between stall alarm and the speed for minimal sink is indeed very small. Hence several pilots have complained about the fact that while circling up in weak thermals at the speed of minimal sink, the stall alarm is triggered sometimes. In this regard there is

an altitude limit to be adjusted by the pilot in *Main Setup Menu* ⇒ *User Settings* ⇒ *Speed* ⇒ *Stallspeed* above which the stall alarm shall not be initiated. In this case naturally, the landing areas should be located below this limit.

Practice has proven that about half of the otherwise unattractive landings have been rescued by pushing the steering bar upright when the stall alarm was triggered.

9.3 Navigation

9.3.1 Reception quality of GPS

The GPS-Receiver can follow up to 16 satellites simultaneously. After turning on the unit it is necessary to receive at least 4 satellites to fix position for the first time. Once logged on, 3 satellites (for 2D positioning) are sufficient for further position finding. However, if altitude recording is also required (3D positioning), then definitely 4 satellites are required. There is a table in the receiver, **The Satellite Almanac**, in which the path, place, and time of all satellites are kept with reference to the receiver. The Almanac is continuously updated during signal reception. However, if the signal to the Almanac memory is disrupted completely or the unit is taken 200 km or more from the last reception point, then the Almanac has to be re-established. Power is still supplied to the almanac's memory even when the unit is turned off.

Normally the instrument recognises its position under unobstructed view condition after a few minutes. If the receiver is switched-off for a short time (less than 2 hrs.), the time for new position finding is less than a minute. Buildings, mountains or thick forest affect reception quality of the receiver. Therefore, you should always look for the best possible visibility around you and the antenna in the casing should point upwards if possible. In particular when mounted on the steering bar of the hang glider, we recommend not to have the instrument fixed under the pilot's head on the middle of the basis, but indeed sideways. In this position the Competino+ should not have more than 45° deviation from horizontal position so that the antenna points upwards.

Due to the fact that receiving strength of the Satellite signals is only approx. 1/1000 of mobile radios, these radio sets and other disruptive factors (like notebooks) should be operated as far away as possible from the Competino+.

The Competino+ is fitted with a 16-channel GPS-Receiver which is featured with lesser power consumption and also a significantly shorter Satellite detection time. Precision is between 7 to 40m. As an average one may assume approx. 15 m.

9.3.2 Accuracy of GPS altitude

A good explanation of GPS accuracy is found on the following website:

<http://www.kowoma.de/en/gps/errors.htm>

First of all the term accuracy has to be defined: On the website above you can read: "The declaration of the accuracy by Garmin GPS receivers sometimes leads to confusion. What does it mean if the receiver states an accuracy of 4 m? This readout refers to the so-called 50 % CEP (Circular Error Probable). This means that 50 % of all measurements may be expected within a radius of 4 m. On the other hand it also means that 50 % of all measured positions are outside of this radius. If one assumes a standard dispersion, then 95 % of all measured positions are within a circle of twice this radius, thus 8m, and 98.9 % are within a circle of 2.55 of the radius, thus in this case within 10 m. "

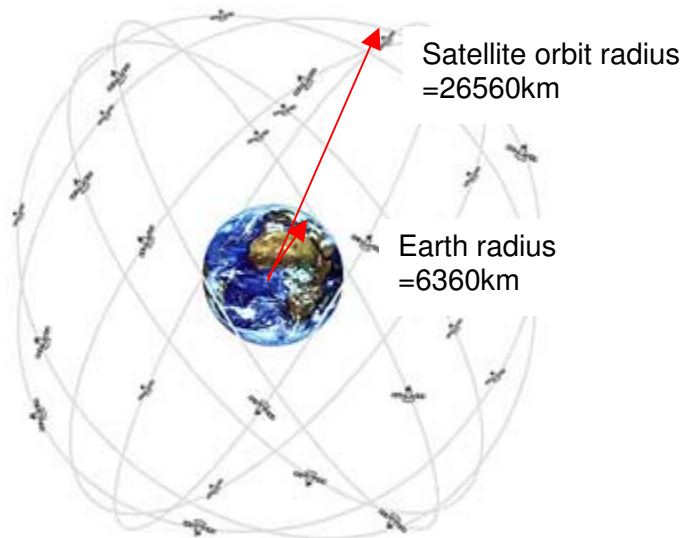

The position is derived from a triangulation. The GPS receiver measures the time of the signals and calculates the distance to the respective Satellite by taking into account the speed of light. Based on three satellites the horizontal position can be determined, and with 4 satellites the spatial position with altitude.

You can find a good explanation of the involved calculation on Wikipedia.

For a spatial position determination (3D position) there are needed 4 satellites, one Satellite is hereby required for synchronisation.

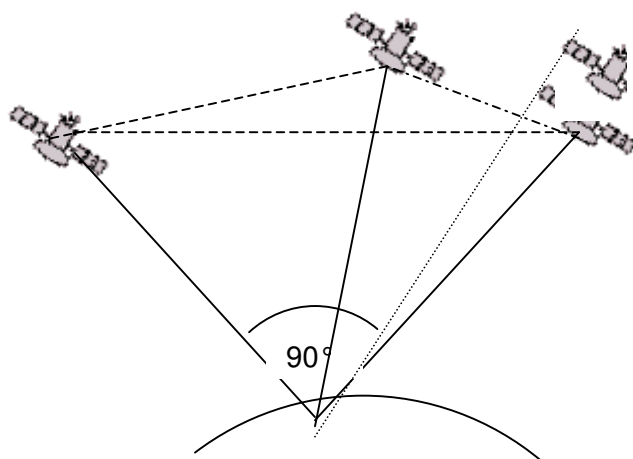

4th Satellite for time synchronisation

Best Accuracy is achieved if the angle between 2 satellites is 90° . The spanned triangle between one's own position and the two involved satellites then has the largest possible surface area. The unit DOP (Dilution Of Position) is proportional to the inverse value of this area

In case of a 3D position identification, best accuracy is achieved if the 3 satellites are 90° to each other. In this case the volume of the spanned pyramid is the biggest. Again the DOP (Dilution Of Position) is the inverse value to the volume of this pyramid.

For a good 2 D position on the earth surface it is best, if you have 2 satellites at 90° near the horizon. So for example, one to the North, the other one to the East. The 3rd Satellite vertically above the position does not contribute to accuracy, it just gives a rough information of the altitude, but which is good enough for a good lat/long determination.

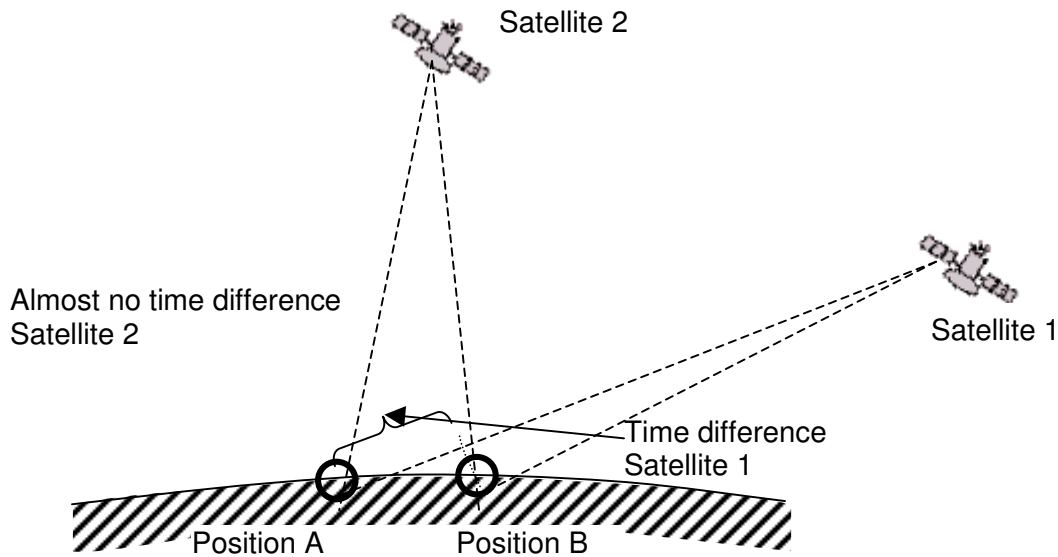

The chance to find 2 satellites near the horizon being at 90° apart, is better than to find 3 satellites with 90° to each other directly above the actual position.

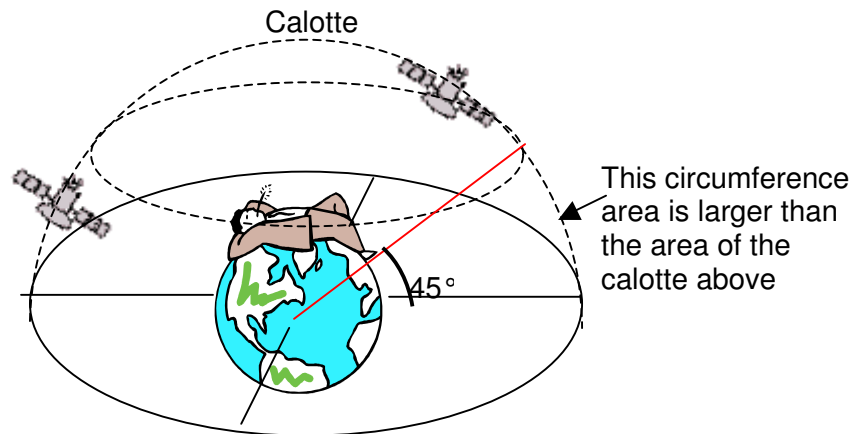

Because the circumference area above the horizon is larger than the area perpendicular above the position, and assuming that the satellites are nearly equally dispersed, there is a bigger chance to find convenient satellites near the horizon. The GPS module will therefore prefer satellites near the horizon. For determination of the horizontal position, the module will calculate any combination of the visible satellites to make an average of these combinations every second.

To do the same with the vertical position, the receiver would need twice the calculation power. Due to the fact that motor vehicles and pedestrians normally require the horizontal position, one saves the effort by computing altitude from the best combination and generates the average by time. This is an explanation of the lower accuracy and the run after or delay of the vertical position.

The GPS module of the Brauniger instruments does not perform a timed filtering over the horizontal position, but in case of good reception quality it does a filtering over approx. 5 s for the vertical position. The poorer the GPS-reception, the longer this time constant.

9.4 Flight optimisation

9.4.1 Final glide calculation

Here the GPS-Data and the McCready theory go hand in hand. Principally it is about reaching a goal (of course it must be logged as a waypoint in the list) as fast as possible, or rather, to get a signal from the instrument of when the last thermal can be left in order to arrive at the WP as fast as possible. In order to be able to establish a statement about this, the distance to this location must be known. This distance will be calculated with help of the GPS-Receiver. In addition, we need the altitude of the waypoint (is mentioned in the list of waypoints), as well as the current altitude of the pilot. From this smallish amount of information it is possible to calculate the required glide ratio over ground (L/D req.) which is necessary to reach the goal. For this purpose all other conditions, such as climb, sink, wind and wind direction, flight speed and polar curve, are left entirely unconsidered. The required glide ratio can be displayed in the user defined fields: **L/D req.** It is only when the **flyable glide ratio** (over ground) has to be determined, that the before mentioned conditions have indeed an important role.

Basically the final approach consists of two phases which are to be considered separately:

- 1.) climbing in the last thermal and
- 2.) the straightest possible glide path to the goal.

The Competino+ does not calculate with the McCready theory, but only with the speed of best glide. In order to reach the goal under optimal conditions all the same, the pilot can take nonetheless some decisions based on the final glide display screen, which will help him to reach goal safely in the shortest possible time. For this purpose it is helpful to keep part of the McCready theory at the back of one's mind. The McCready theory declares that one is flying time optimised if, after having left the thermal, one would be flying as fast as one would be in a descending air mass at the same speed as would be the day specific climb in the thermal. This speed value has to be calculated from the polar curve and the resulting figure is the speed to fly. Given the fact that the Competino+ does not compute with the polar curve, one needs to estimate this „optimal“ speed by himself.

1.) Let's assume that the pilot is circling under a cloud in quite a good thermal which provides to him an average climb of 2 m/s. While circling he will naturally try to fly with the speed for minimum sink. If, while circling, the nose of the aircraft turns again and again in the direction of the goal, the wind component, and, derived from this the wind factor, may be determined at this moment and consequently the glide ratio over ground (Gnd) can be calculated.

From the distance to goal and the glide ratio (gnd) the Competino+ calculates the loss in height which the pilot requires on his glide path to the goal. If the altitude of the goal is added (for each WP also its altitude is saved), then we obtain directly the minimum departure altitude. The own altitude is known, therefore the instrument can now display directly by comparison at which altitude is reached the path of best glide and if we still have to thermal up to arrive safely. It is of course subject to the pilot's experience whether he wants to take-off immediately upon positive „Diff. BGWayp“, or whether he will prefer to climb up further and take some reserve altitude.

The Competino+ naturally does not know whether in the course of the glide path lifting or sinking air mass zones are incorporated, or if the wind intends to change. The instrument calculates with the current wind and assumes that no lifting or sinking zones are to be expected.

On the one hand one will climb for safety reasons somewhat above the path of best glide. On the other hand one will climb still slightly higher on a day with good thermal and then slowly annihilate this reserve altitude when gliding down by flying faster with consequently earlier arrival.

2.) Gliding down to Goal

The pilot has left the thermal with sufficient safety altitude above the path of best glide and is flying towards his goal. He should speed-up until the display „Diff.BGWayp“ will begin to decline slowly. This display indicates that by flying faster, one is annihilating slowly the altitude reserve. However, one should look out for sinking air mass or head wind. This is shown when the display „Diff.BGWayp“ is declining more quickly and when the paraglider symbol on the final approach display screen is moving faster towards the intersection. In this case it is recommended to fly at a more slowing rate again.

For all previously made considerations we assumed that the wind component is automatically calculated from the difference: Gndspeed – Airspeed. However, there are good reasons which justify to overwrite this automatically logged Spd-Diff with a manually entered value.

1. While circling up in thermals the wind prevailing outside of the thermal shall always be stronger than the measured one. The strength is dependent on the value of climb and also on the fact if the pilot is at the top or at the bottom of the thermal.
 2. As for the final approach, also slight wind fluctuations, for ex. when induced by yaw will take effect on the pre-calculated arrival altitude. A wind component logged as fixed value shall then calm the result.
 3. When the pilot being in down glide from high altitude knows by experience, in which way the wind shall change in the lower layers, he can consider this already in advance.
- 10 When para glider pilots fly without speed sensor, the manually logged wind component can provide a significant improvement of final glide calculation.

10.1.1 Safety altitude (Alt a. BG)

The display „Alt a. BG“ indicates the pilot's current altitude above (or below) the path of best glide leading to goal. The safety altitude (Alt. over Alt a.BG) is also this altitude which one could safely lose when flying through a sinking air mass and could still make it to goal.

„Alt a. BG“ can also be shown continuously in the user selectable fields. It is only then identical to „Alt a. WP“ if the pilot flies with the speed of best glide.

The fields „Alt a. BG“ and „Alt a. WP“ will switch to inverse display during thermal circling at the moment when the pilot could leave the thermal (Alt a.BG) in order to just arrive safely; or when the pilot should definitely leave the thermal (Alt a. WP) in order to reach the selected WP as fast as possible. (see picture on page 17).

10.1.2 Final Glide calculation over several Waypoints

As of the Competino+ a new user selectable field „Alt a. Goal“ has been added. This is a pre-calculation, based on best glide ratio, of required altitude above (or below) the last WP of a Route, irrespective of how many WP's are still in front of the pilot. The related actual wind vector is taken into account for all sectors, as well as the differing glide ratio values resulting from it. Naturally this result requires that the detected wind does not change on the way to goal.

The wind vector is updated again by each flown full circle.

10.2 Flight Memory and IGC File

10.2.1 Content of IGC Files

In the IGC File are saved all important data of a flight in readable format. One can open the IGC File by using any desired Editor.

Though editing or modifying is possible, the signature at the end of IGC File shall be changed to invalid. This signature is calculated over all data and therefore covers the flight, as well as

the pilot's personal data and the date. The signature is generated by the instrument. The misapplication is therefore practically excluded.

Sometimes it is helpful if one can import to Excel the raw data being stored in the IGC File in order to practice own calculations.

Please proceed as follows:

In Excel program click on open / file

Select file type **all files**.

Follow the 3 Import steps.

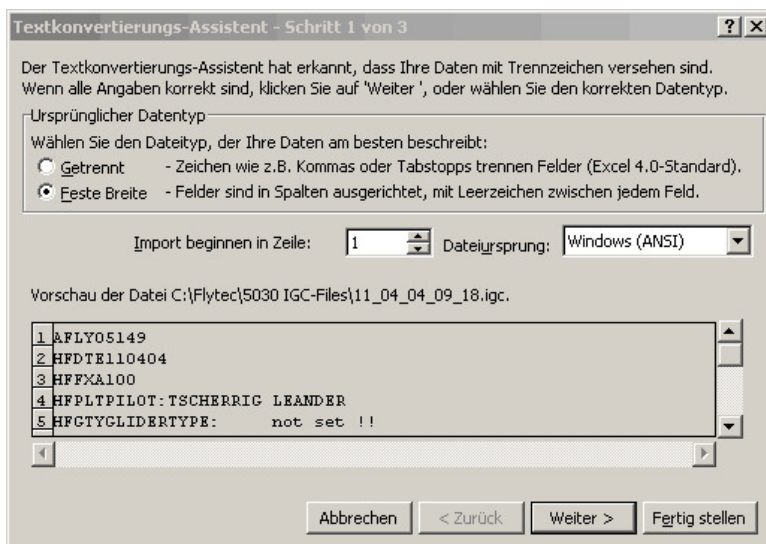

Set the arrows for column disjunction as follows:

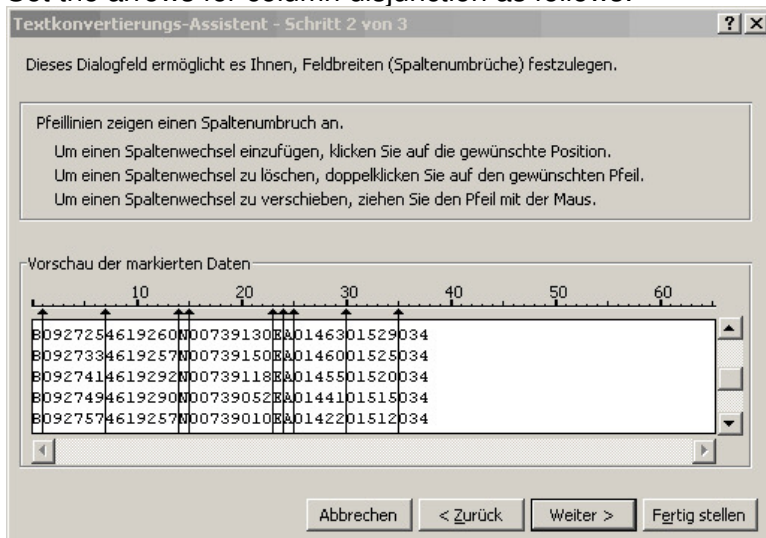

Select standard format for columns

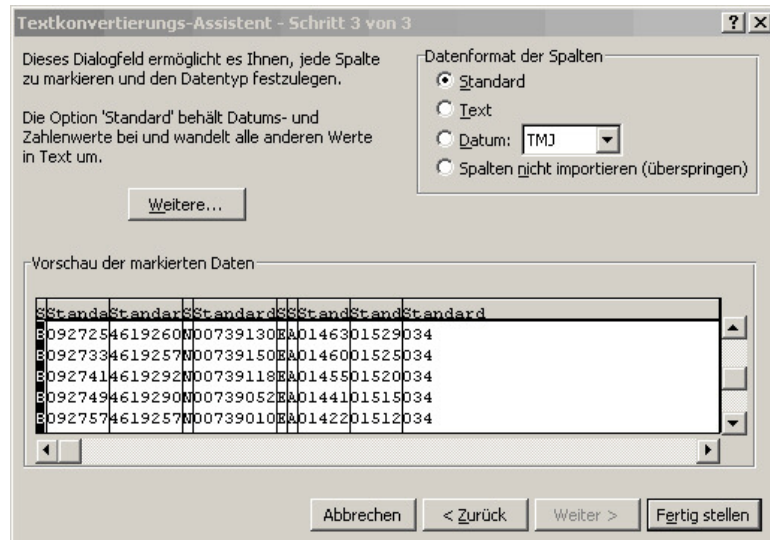

The present head in lines 1 – 13 contains internal flight data. These are no longer required and can be erased.

	A	B	C	D	E	F	G	H	I	J
1	A	FLY051	49							
2	H	FDTE11	404							
3	H	FFXA10	0							
4	H	FPLTPI	LOT:TSC	H	ERRIG LE	A	N	DER		
5	H	FGTYGL	IDERTYP	E	: no	t		set !	!	
6	H	FGIDGL	IDERID:		5 876 not	s	e	t !!		
7	H	FDTM10	DGPSDAT	U	M:WGS84					
8	H	FGPSGP	S:FURUN	O	GH-80					
9	H	FRFWFI	RMWAREV	E	RSION:2.	1	5			
10	H	FRHWHA	RDWAREV	E	RSION:1.	0	0			
11	H	FFTYFR	TYPE:FL	Y	TEC,5030					
12	H	PTZNUT	COFFSET	:	02:00					
13	I	13638	TAS							
14	B	91525	4619616 N		740199 E	A	1346	1401	34	
15	B	91533	4619616 N		740200 E	A	1346	1401	34	
16	B	91541	4619616 N		740201 E	A	1346	1401	34	
17	B	91549	4619616 N		740201 E	A	1346	1401	34	

For better understanding content and unit of columns are captioned.

	A	B	C	D	E	F	G	H	I	J
1										
2		Time UTC	Latitude X	Breitengrad	Longitude Y	Längengrad	Fix Validity	Altitude	Altitude	Speed
3		HHMMSS	DDMMmm	N/S	DDMMmm	E/W	A oder V	Druck	GPS	SSS
4		09.15.25	46°19.616	N	7°40.199	E	A=3D V=2D	(bei 1013hPa)	(vom GPS)	km/h
5										
6	B	91525	4619616 N		740199 E	A		1346	1401	34
7	B	91533	4619616 N		740200 E	A		1346	1401	34
8	B	91541	4619616 N		740201 E	A		1346	1401	34
9	B	91549	4619616 N		740201 E	A		1346	1401	34
10	B	91557	4619616 N		740202 E	A		1346	1401	34
11	B	91605	4619616 N		740203 E	A		1346	1401	34

The columns now have to be set into the configuration required by the Software
Caution: the Coordinate are in XX°XX.XXX' format. Therefore the number 4619616 should be read as 46 degrees 19.616 minutes, which corresponds to 46°19'39.96".

More information in regard to IGC Format is available on the FAI Website under:
http://www.fai.org/gliding/gnss/tech_spec_gnss.asp

10.2.2 New Regulations for Record flights or decentralised Competitions (OLC)

Since the evidence of a completed flight depends entirely on the GPS recording, it is important to ensure before take-off that the GPS-receiver indeed receives satellite signals. Therefore please switch-on the Competino+ at least a few minutes before take-off so

that even pre-flight events are included in the recording.

The Barogram is also included in the IGC-File which is generated for each flight. Photographic evidence and confirmation by flight observers are no longer required for national performance flights. The file can be sent directly to the judging committee of the OLC via the Internet. (at present, the OLC is evaluated in Germany by the DHV).

10.2.3 Evidence of flights - Safety against Manipulation

The FAI (Fédération Aéronautique Internationale) and its subgroup IGC (International Gliding Committee) require a recording format which, while memorising continuously the time of day, position and also the flight altitude, and therefore substitutes the barograph. When transmitting flight data to the pilot's PC, a so-called IGC-File is created, which receives a digital signature (=G-Record) authenticating the flight data and making it fraud-resistant. If only one character of the file containing the flight would be changed, the signature would no longer be compliant to the data and the judging committee would be aware of the manipulation.

10.2.4 Digital Signature and OLC-Registration

The popularity of decentralised competitions has been growing enormously over recent years. Meanwhile 26 countries have accepted the OLC (Online Contest) convention. These agreements state that any pilot can submit flights at will over the Internet for approval and evaluation. The submission has to be compliant to IGC-format (WGS84) and must have a digital signature. In order to facilitate further on the utilisation of usual GPS-Receivers, relevant PC-evaluation programs such as Compegps, Gpsvar, Maxpunkte or Seeyou calculate a digital signature to allow submission of flights in the required form. However, a "signature" created by PC provides only half the safety against falsification. In the long term this signature shall be mandatory to be provided by the GPS-Recorder instruments, as for ex. the Competino+.

After completion of a flight, effected automatically or manually, this „Digital Signature“ is calculated autonomously by the Competino+ and added to the flight data file as so-called

G-record. A correlative remark „Generating Digital Signature“ is displayed in the info field of the instrument. As this calculation is extremely complicated, it may take several minutes following a long flight with setting of a short scan rate.

Please wait until this message will disappear.

Should it once happen that the OLC does not accept the digital signature upon the transfer of flight data, the signature can be recalculated on the flight analysis display, by pressing the key **F2** Recalc Signature „Rec Sig“.